

Mitre-Mite™

VN4 MemoryProgram

Instruction Manual

Version L



AMP

A Fletcher Company

859 West End Court - Unit 103 - Vernon Hills, IL 60061

Phone - 800-322-4204 Fax - 800-426-7019

Index

1. GENERAL INFORMATION	4		
1.1 PRODUCER	4		
1.2 ASSISTANCE CENTERS	4		
1.3 CERTIFICATION	4		
1.4 WARRANTY	4		
1.5 PRE-ARRANGEMENTS CHARGED TO THE CUSTOMER	4		
1.6 HANDBOOK STRUCTURE	4		
1.6.1 Object and contents	4		
1.6.2 Utilizers	4		
1.6.3 Preservation	4		
1.6.4 Symbols utilized	5		
2. MACHINE DESCRIPTION	6		
2.1 WORKING PRINCIPLE	6		
2.2 MAIN COMPONENTS	6		
2.3 MACHINE STRUCTURE	6		
2.4 DIMENSIONS	6		
2.5 SURROUNDING CONDITIONS	6		
2.6 LIGHTING	6		
2.7 VIBRATIONS	6		
2.8 NOISE EMISSIONS	6		
2.9 TECHNICAL DATA	7		
2.10 STANDARD EQUIPMENT	7		
2.10.1 Standard accessories	7		
2.10.2 Upgrading and implementing of mechanical parts	7		
2.10.3 Customized optional accessories	7		
2.11 ELECTROMAGNETIC AMBIENT	7		
3. SAFETY	8		
3.1 GENERAL WARNINGS	8		
3.2 SCHEDULED USE	8		
3.3 INADVISABLE USE	8		
3.4 DANGEROUS AREAS	8		
3.5 PROTECTION DEVICES	8		
3.6 STOP FUNCTIONS	8		
3.7 SAFE WORKING PROCEDURES	8		
3.8 RESIDUAL RISKS	9		
3.9 PLATES	9		
4. INSTALLATION	9		
4.1 SHIPPING AND HANDLING	9		
4.2 STORAGE	9		
4.3 PRELIMINARY ARRANGEMENTS	10		
4.4 UNPACKING	10		
4.5 MACHINE POSITIONING	10		
4.6 CONNECTIONS	10		
4.6.1 Pneumatic connection	10		
4.6.2 Electric connection	10		
4.6.3 Collegamento elettrico della tastiera di controllo	11		
4.7 PRELIMINARY CONTROLS	12		
4.8 MACHINE ARRANGEMENT	12		
		4.8.1 V-Nails magazine loading	12
		4.8.2 V-nail guide head replacement to change V-nails size	12
		4.9 ADJUSTMENTS	13
		4.9.1 Adjustments for v-nails positioning	13
		4.9.2 VERTICAL CLAMP ADJUSTMENT	13
		4.9.2.A Vertical clamp position adjustment	13
		4.9.2.B Vertical clamp height adjustment	13
		4.9.3 Frontal clamp adjustment	14
		4.9.4 FENCE ADJUSTMENT	14
		4.9.5 Working pressure adjustment	14
		4.9.6. Protective shield adjustment	15
		4.10 CHECKING OPERATIONS TO BE EFFECTED BEFORE WORKING START	15
		5 FUNCTIONING	16
		5.1 OPERATORS	16
		5.2 CONTROL PANEL	16
		5.3 KEYBOARD CODE/COLORS OF ELECTRONIC CONTROL DEVICE	17
		5.4 Mode of operation	18
		5.4.1 Manual functions menu	18
		5.4.2 Jog menu	18
		5.4.3 Input test menu	18
		5.4.4 Output test menu	18
		5.4.5 Machine zero point (homing)	19
		5.4.6 Editing menu	19
		5.4.7 Rename	19
		5.4.8 Copy	19
		5.4.9 Delete	19
		5.4.10 Search	19
		5.4.11 Creation of new programs	19
		5.4.12 Execution menu	21
		5.4.13 Working speed modification	22
		5.4.14 Enabling access code protected services	22
		5.5 FRAMES PRODUCTION AND V-NAILS CONSUMPTION	23
		5.6 TIPS FOR PERFECT JUNCTIONS	23
		5.7 MACHINE STOP	24
		5.8 PUTTING OUT OF SERVICE	24
		6. PROGRAMMING	25
		6.1 CREATION OF A PROGRAM	25
		6.1.A. Auto-learning mode	25
		6.1.B Inputting mode	25
		7. EXECUTION OF THE PROGRAM	26
		7.1 EXECUTION OF JUST DIGITED PROGRAM	26
		7.2 EXECUTION OF A PROGRAM PREVIOUSLY MEMORIZED	26
		7.3 MACHINE ADJUSTMENT	26
		8. MAINTENANCE	27
		8.1 STATE OF MAINTENANCE	27
		8.2 MACHINE ISOLATION	27
		8.3 SPECIAL CAUTIONS	27
		8.4 CLEANING	27
		8.5 LUBRICATION	27
		8.6 ORDINARY MAINTENANCE	27
		8.7 EXTRAORDINARY MAINTENANCE	28

9. DIAGNOSTIC	29
9.1 SAFETY WARNINGS	29
9.2 BREAKDOWN SEARCH	29
9.3 REQUEST OF ASSISTANCE	30
10. SPARE PARTS	31
10.1 SPARE PARTS LIST	31
10.2 SPARE PARTS ORDERING	31
11. DEMOLITION	31
11.1 DEMOLITION	31
12. ATTACHMENTS	31
12.1 DECLARATIONS	31
12.2 SCHEMES	31

1. GENERAL INFORMATION

1.1 PRODUCER

The firm Alfamacchine-AMP can boast more than 10 years of experience in the construction of Woodworking Machines. It is the acquired technological know-how, developed during years of research in strict touch with manufacturing departments and international commercialization. We offer the best warranty that anyone can grant to its customers.

TEL 800-322-4204

FAX 800-426-7019

1.2 ASSISTANCE CENTERS

AMP is represented throughout North America. Contact us directly to find your nearest distributor. For every need regarding Use, Maintenance or Request of Spare Parts, the Customer is requested to call the authorized service centers or directly to AMP, specifying the machine's identification data impressed on the plate.



1.3 CERTIFICATION

The machine is produced in conformity to the pertinent European Community Norms in force at the moment of its introduction on the market.

1.4 WARRANTY

AMP's products are built to have a long life and are tested one by one. If, in spite of this, if any damages would occur or malfunctioning, the replacement of defective parts is warranted (counting from the date written on the delivery bill) for a period of:
* 24 months for mechanical components
* 12 months for pneumatic part
The driver blade is tested for about 1.000.000 working cycles.
The Warranty does not include the sending of technical staff.
The repair will be performed at AMP and the freight of shipment will be entirely charged to the Customer.

The warranty does not cover the damages caused by an inappropriate use of the machine or not corresponding to the instructions described in this handbook.

The warranty decays in case of unauthorized modifications or because of accidental damages or tampering performed by unqualified personnel. The warranty also decays if you use V-nails different from the original AMP's ones.

To take advantage of warranty services it is necessary, at the moment you receive your machine to completely fill out the warranty card and send back as soon as possible to AMP.

The warranty will be valid after it is received & recorded at AMP.

1.5 PRE-ARRANGEMENTS CHARGED TO THE CUSTOMER

It is the customer's duty, on times agreed with the producer, to execute what is indicated in our documentation (see the attachment 10.3-B). Things normally charged to the customer:

- Premises predisposition, included building works
- Machine power supply, observing the current norms of Country where the machine is installed (see at the paragraph 4.6.2)
- Pneumatic supply of compressed air (see at the paragraph 4.6.1)

1.6 HANDBOOK STRUCTURE

The customer must pay extreme attention to the indications reported in this handbook, because the proper Pre-Arrangement, Installation and Use of the Machine, constitute the basis of a correct customer-distributor relationship.

1.6.1 Object and contents

The handbook goal is to provide to the customer all necessary information so that, besides the proper use of the machine, He would be able to run it in complete autonomy and safety. The handbook contains information concerning the technical aspects, machine working and standstill, maintenance, spare parts and safety. Before making any operation on the machine, the qualified technicians and operators must carefully read this handbook. In case of doubt about correct interpretation of the instructions, ask your local distributor or AMP to explain it to you.

1.6.2 Utilizers







This handbook is made both for operators and technicians authorized to the machine maintenance. The operators cannot execute operations reserved to the maintainers or to the qualified technicians.

The producer does not answer of damages derived from non-observance of this prohibition

1.6.3 Preservation

The instruction handbook must be kept very closed to the machine, into a special container protected from liquids and whatever could compromise its legibility

1.6.4 Symbols utilized

 P...	DANGER	It indicates a danger with a mortal risk for the operator
 A...	WARNING	It indicates a warning or a note about key functions or useful information. Pay the maximum attention to the paragraph marked with this symbol.
 O...	OBSERVATION	It is requested to take a measurement data, to check a signal,....
 I...	INQUIRY	The user is requested to check the proper positioning of any element of the machine, before operating a certain command
 C...	EXAMINATION	It's necessary to consult the handbook before effecting a certain operation
 R...	ADJUSTMENT	In case of strange working and/or anomalies, can be requested a certain mechanical adjustment and/or electrical setting

2. MACHINE DESCRIPTION

2.1 WORKING PRINCIPLE

The frame assembling machine Mitre-Mite VN 4 Memory Program has been realized for the mass production of medium or large sized frames.

The machine is controlled by an electronic system able to execute very quickly the different working cycles.

You can store in the machine's memory 1.400 different programs corresponding to several types and sizes of frames.

The machine can work only semi-automatically controlled by a program input by the operator. The frame assembling machine Mitre-Mite VN 4 Memory Program can use special V-nails with "pulling power" to pull the joints tightly together.

2.2 MAIN COMPONENTS

The main components constituting the machine are:

- Frontal clamping device to have a perfect joint.
- Floor stand with Filter/regulator/lubricator
- Double Hydraulic hold down
- Double & triple mechanical hold downs
- Pneumatic opening of V-nails magazine for a very quick reloading
- Nail heads sizes 7, 10 and 15 mm.

2.3 MACHINE STRUCTURE

The movement directions during the machine working are the followings:

- X AXIS

Movement of horizontal clamp

- Y AXIS

Movement of vertical clamp



2.4 DIMENSIONS

The overall dimensions are reported on complete drawing of table 2.9-A

2.5 SURROUNDING CONDITIONS

The machine does not need special surrounding conditions. It has to be installed inside an industrial building, lit, aired and with a compact and flat floor. The admitted temperatures go from 40° to 104° F, with an humidity not higher than 50% at 104° F or 90% at 68° F.

2.6 LIGHTING

Premises lighting must be conformed to the norms in force in that Country where the machine is installed and has to guarantee a clear visibility and can not create dangerous reflections.

2.7 VIBRATIONS

In standard conditions conformed to the indication of machine proper utilization the vibrations do not create dangerous conditions. The average quadratic weighed level, according to the acceleration frequency to which arms are exposed does not exceed 2,5 m/s².

2.8 NOISE EMISSIONS

The machine is designed and projected for reducing the noise emission level to its source. In standard working conditions the Machine noise power level is:

- Acoustic Continuous Equivalent weighed pression A <70dB
- Acoustic Istantaneous weighed pression <130dB

The noise levels indicated are emission levels and are not representative of operating levels. In spite of an existing relationship between emission levels and exposure ones, this can not be used in a reliable way to define if further precautions are necessary. The factors determining the exposure level to which the working force is subjected, include exposure length, working premises characteristics and other noise sources (number of machines, closed bldg., etc...). Furthermore, also the allowed exposure levels could change according to several Countries. At any rate, the information provided, will allow the Machine Operator to achieve a better evaluation of the danger and risks he is submitted to.

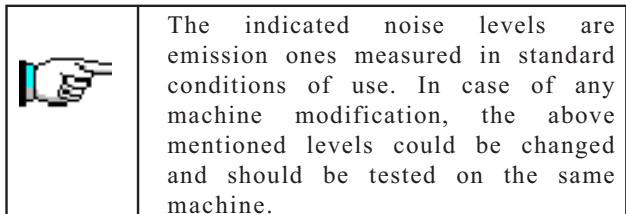

2.9 TECHNICAL DATA

We have listed below the Machine data and technical characteristics to which you can make reference for any eventual contact with Producer for Technical Assistance.

- Frames thickness min-max	.197" - 3.15"
- Frames width min-max	.39" - 3.94"
- Max distance between V- nails	4.72"
- V-nail magazine capacity	n. 220
- V-nails size	7, 10, 15 mm.
- V-nails size on request	3, 5, 12 mm.
- Pneumatic supplying	Psi 80-110
- Power supplying	120 V
- Weight	about 254 LB
- Height of working bench	37.8"
- Overall dimensions	30.3"x30.3"x5.9"
- Max programming capacity	n. 1400
- Max V-nails inserting position	n. 10
- Max V-nails stacking per position	n. 9
- Serial linking support	type RS 232
- Air consumption per cycle	4 NI/5 Bar

2.10 STANDARD EQUIPMENT

The equipment listed below are the standard ones:

2.10.1 Standard accessories

Once you have removed the packing, please check the presence of following accessories:

- N.1 nail head mm. 7
- N.1 nail head mm.10
- N.1 nail head mm.15
- N.1 L shaped pressure pad
- N.1 Allen Wrench 5 mm. for V-nails head replacement
- N. 4 adjustable feet.
- N.1 pressure gauge
- N.1 fast clutch fitting
- N.1 Brass rod magnet to remove V-nails
- N.1 double hydraulic hold down
- N.1 double & triple mechanical hold down

2.10.2 Upgrading and implementing mechanical parts

The machine has been designed and developed based on modular standards, therefore the existing equipment can be further upgraded with additional accessories that will not alter its basic structure.

Technical upgrades on the machine model, if any, will be such that they can be installed at any time without requiring any substantial modifications to the machine structure.

2.10.3. Customized optional accessories

Thanks to its versatility this machine can be 'custom-made' to meet our users' requirements, by using additional accessories that can make frame assembling easier: e.g. special fences for peculiar moulding shapes, special clamps to ensure the mouldings are locked properly during V-nail firing, and so on. You can have your local machine shop make these for you.

2.11 ELECTROMAGNETIC AMBIENT

The Machine is designed to operate properly in an industrial electromagnetic ambient, being included in the following Norms about Emission and Immunity:

EN 50081-2 Electromagnetic compatibility- Generic Norm on Emissions-2nd part-Industrial Environment-(1993)

EN 50082-2 Electromagnetic compatibility- Generic Norm on Immunity-2nd part-Industrial Environment-(1995)

3.SAFETY

Figure 3.4.A- Working area and dangerous zones

3.1 GENERAL WARNINGS

The operator must read paying the maximum attention to the information written in this Handbook, expressly about proper precautions for Safety listed in this chapter.

It is indispensable for the operator to follow the warnings list here below:

- Keep the machine & it's working area clean & ordered
- Provide appropriate containers to stock moulding to be used.
- Use the Machine only in perfect psycho physical condition
- Wear an adequate clothing to avoid obstacles and/or dangerous entangles to/from the machine
- Wear the individual protection gears prescribed by this instructions handbook
- Do not remove or alter the warning plates and adhesive signs
- Do not remove or elude the Machine Safety Systems
- Keep the fingers away from the working area
- Disconnect the air pressure and power supply during any maintenance intervention
- Keep the feet separated from the pedal during Machine repair

3.2 SCHEDULED USE

The Machine is designed and built to execute junctions of frames.

The machine is projected for semi-automatic operation (under operator control).

3.3 INADVISABLE USE

The machine can not be used for:

- For uses different from those listed in 3.2 paragraph
- In an explosive or aggressive atmosphere, where there is a high density of dust or oily substances suspended in the air
- In flammable atmosphere
- Outside in all weather severity
- With disconnected electromagnetic interblocks
- With electric bridges and/or mechanical instruments leaving out machine parts or functions
- For working materials not suitable with machine characteristics

3.4 DANGEROUS AREAS

The area of frames assembly is defined as the "working area"

The dangerous areas of machine, include the movable parts and surrounding zones



3.5 PROTECTION DEVICES

The machine is equipped with adequate protections for persons exposed to the risks due to the transmission mobile elements, or movable organs taking part in working (driver blade, horizontal clamp, vertical clamp).

3.6 STOP FUNCTIONS

The machine stop functions are the following:

- Stop Category 0.
- Stop Category 1.

STOP CATEGORY 0

It is obtained by disconnecting the fast clutch fitting from the feed system (uncontrolled stop). It is obtained by flipping the main switch located on the floor stand.

STOPCATEGORY 1

Controlled stop obtained by lifting the foot from the pedal which will not allow the v-nails firing.

3.7 SAFE WORKING PROCEDURES



The machine is projected and realized to eliminate any risk connected with its use.

The user is requested to achieve an adequate training to be instructed by their distributor.

The other risks related with working are:

- Finger crushing in the vertical clamp working area
- Finger crushing in the frontal clamp working area

It is necessary to carefully adhere to the following instructions:

- 1 Keep the fingers away from frontal and vertical clamp working areas
- 2 Disconnect the air pressure and the power supply during any maintenance interventions
- 3 Keep the foot away from the pedal during machine maintenance.

4. INSTALLATION

3.8 RESIDUAL RISKS

During the normal working cycle and while performing maintenance, the operators are exposed to several residual risks that, because of operations own nature, can not be totally eliminated.

- Risk of finger crushing due to the presence of vertical and frontal clamping
- Risk due the presence of electricity in the machine

3.9 PLATES

The warning plates carrying out safety functions can not be removed, covered or damaged.

To view the plates or adhesive signs location, consult the Fig.10.2-D

Table 3.9 A- Types of plates



Plate concerning machine characteristics



Adhesive sign concerning the finger danger zone



Adhesive sign concerning the behaviour to be kept in the working area



Adhesive sign concerning the finger danger zone

4.1 SHIPPING AND HANDLING

The shipment must be performed by qualified technical staff. The machine has to be shipped in a safe way to avoid any damage to its parts.

- All the protections & guard devices must be properly closed and clamped.
- The machine has to be shipped like positioned for installation.
- Before shipment, it is necessary to lubricate the parts which are not painted to avoid rusting them.
- According to the type of shipment, it is necessary to protect the machine from any jarring impact or stress

Figure 4.1A - machine handling indications

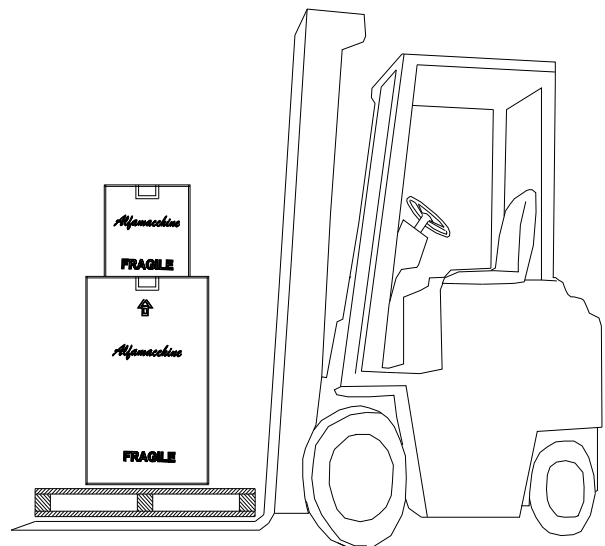

Machine's total weight: about 380 Kilos

Any damage of the machine caused during its shipment or handling is not covered under warranty.

Repairs or replacements of damaged parts are charged to the customer.

4.2 STORAGE

In case of long inactivity, the machine must be stored with cautions concerning storage place and times.

- Store the machine indoors
- Protect the machine from jarring impacts and stresses
- Protect the machine from humidity and high temperatures
- Avoid corrosive materials that could touch the machine
- Lubricate parts which are not painted

4.3 PRELIMINARY ARRANGEMENTS

To install the machine it is necessary to prepare a working area adequate to the machines dimensions, lifting devices chosen and length of mouldings to be worked.

4.4 UNPACKING

The machine is shipped on a wooden pallet, packed into an appropriate carton and protected with foam and polyurethane parts.

Remove the external packing and save it for future use.

Check for any casual shipping damage and report it immediately. Shipping damages or any other defects must be reported to AMP within and not later than 3 days from receipt of the machine.

4.5 MACHINE POSITIONING

Position the machine in its working area. Screw in the provided levelers to the floor stand and level the machine by releasing or tightening the levelers.

4.6 CONNECTIONS

To avoid any problems while starting up the machine, it is suggested to follow what is described below.

4.6.1 Pneumatic connection

Unscrew the lubricator bowl out from the air filter lubricator."C"

Fill the bowl with lubricating oil up to the level mark.

Screw the "A" pressure gauge on the air filter. Screw the "B" fast clutch fitting normally supplied or another suitable with the existing system. (See picture 3)

Connect the feed line to the fitting. (See picture 4)

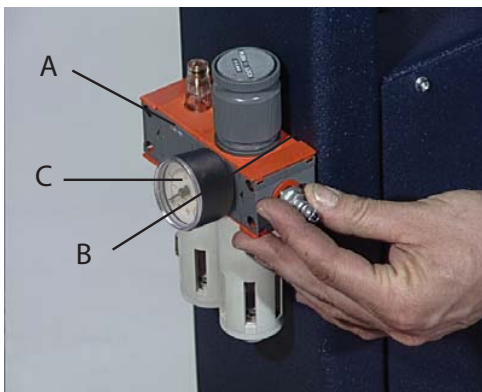

Picture 3

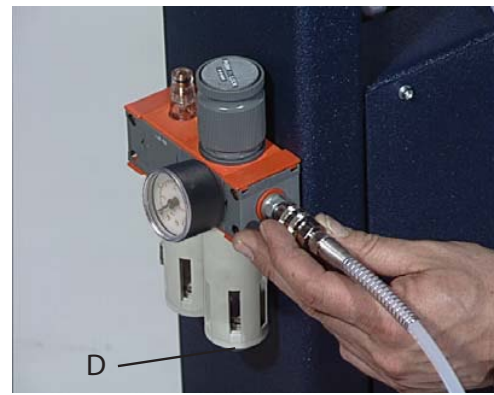

Picture 4

	<p>In the lubricator it is advisable to use lubricant type CASTROL MAGNA GC 32 or an equivalent lubricant. Don't use generic lubricants ! The use of non-suitable lubricants might damage the valves.</p>
---	---

	<p>In order to eliminate the condensation in the filter press upwards on the "D" valve (see picture 4).</p>
---	---

4.6.2 Electric connection

Check the network Voltage: it must be the same of what indicated on machine cable (120 V). Connect the power supplying cable to the plug positioned on the machines rear side.

Avoid the use of long extension cables.

Put the switch (E) on "1" which is located on the floor stand to switch on the machine.

Check that the green light next to the switch is lit (if not, check the electric connections). Rotate clockwise the emergency mushroom headed button located on the keyboard.

Press the green button of the keyboard to activate the keyboard controls.



4.6.3 Electric connection of the control keyboard

Proceed as follows, in order to perform the connection of the control keyboard:

- Connect the "A" terminal of picture 4.6.3 together with the "a" terminal of picture 4.6.4
- Connect the "B" terminal of picture 4.6.3 together with the "b" terminal of picture 4.6.4
- Connect the "C" terminal of picture 4.6.3 together with the "c" terminal of picture 4.6.4

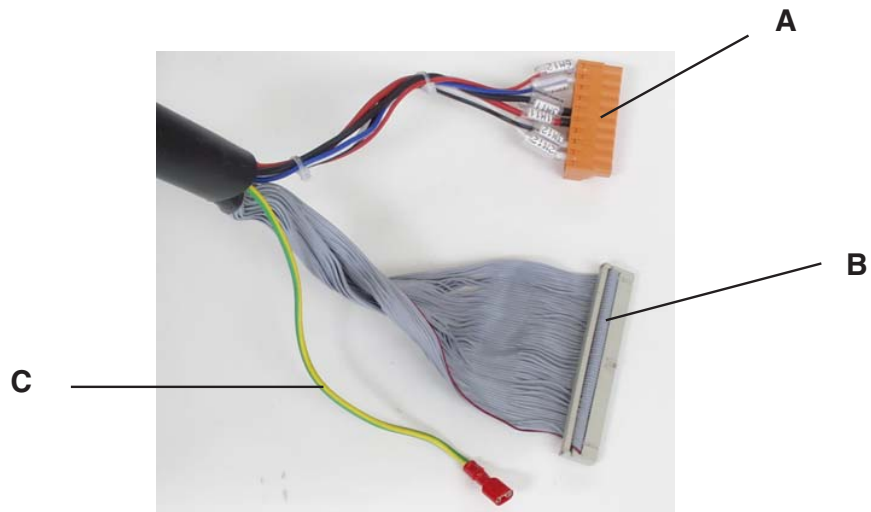

Picture 4.6.3

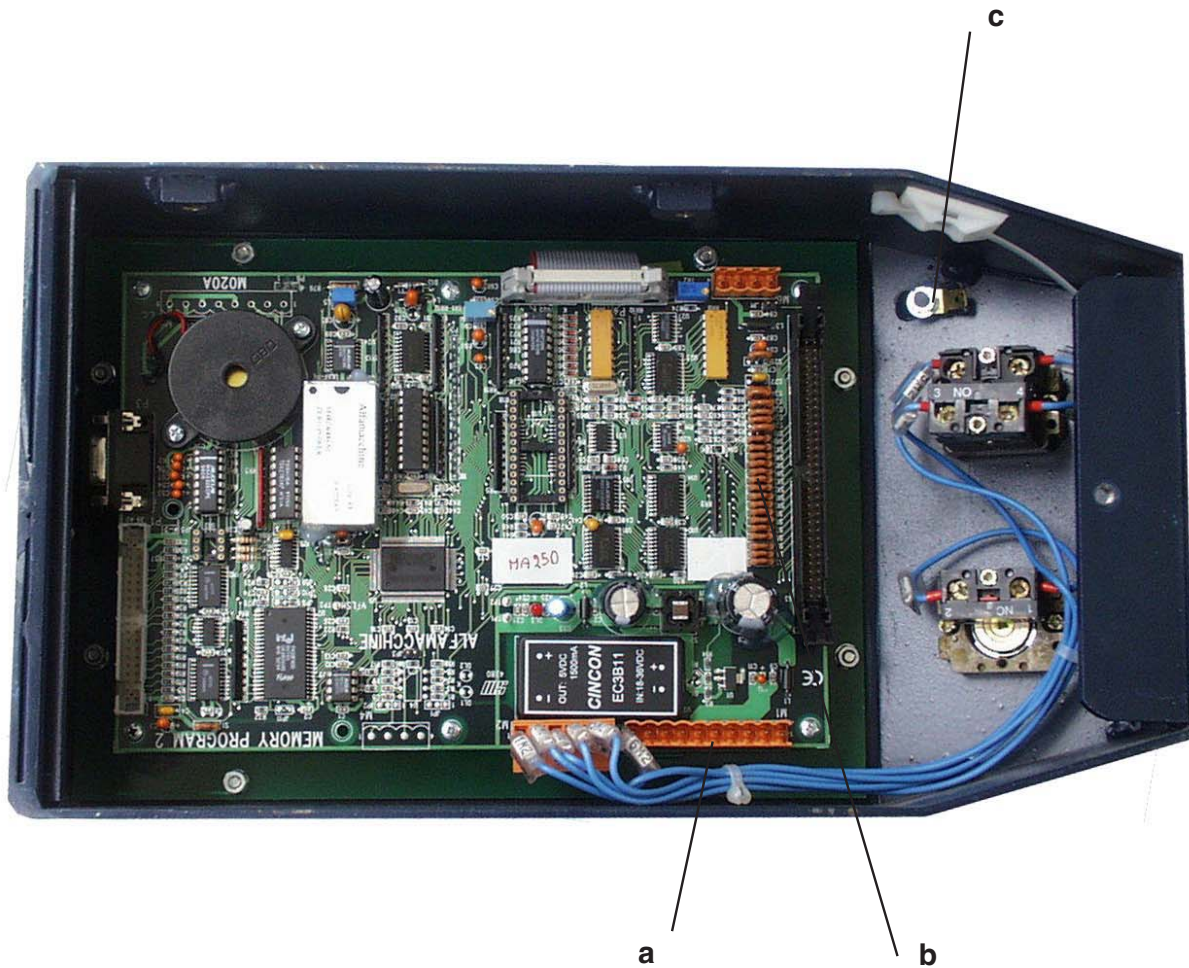

Picture 4.6.4

4.7 PRELIMINARY CONTROLS

The Machines preliminary operations before you 1st start the machine, must be executed by a technician appointed by the customer. Before machine commissioning, it is necessary to execute certain verifications and checks to prevent mistakes or accidents during the setup.

The verifications to execute are the followings:

- Verify that machine has not been damaged during assembly steps.
- Verify with extreme care, the integrity of electric boards, control panels, electric cables, wires and pipes
- Check the proper connection of external power sources

4.8. MACHINE ARRANGEMENT

4.8.1 V-Nails magazine loading

To load the V-nail magazine proceed as follows:

- Move the claw pusher backwards by flipping the special lever located on the right side of the machine working bench. This will make the V-nail magazine accessible (see fig. 6).
- Insert one or more V-nails strips, taking care that the sharpened edge of the V-nails (glue side) faces up and that they are loaded with the V of the V-nails pointing in the direction indicated in the figure 7. You also need to check that the v-nail size is the same as the type of claw head mounted.
- Move the claw pusher forward by flipping the control lever (see figure 6).



Figure 6



Figure 7

TAKE CARE: When the magazine runs short of V-nails, or when it contains an amount of V-nails that is not sufficient to complete a working cycle, the machine will stop at the next foot-pedal pressure and warn the operator with three beeps and a message on the display- informing the operator that magazine is running short of V-nails.

4.8.2. V-nail guide head replacement to change V-nails size

The V-nail guide head must be changed each time you use V-nails of different sizes.

Proceed as follows to change it:

- Move the claw pusher backwards by flipping the special lever located on the right side of the machine working bench, this will permit access to the nail magazine (see fig. 6).
- Remove all the V-nails that are still in the magazine (using the proper brass magnet, if necessary) (see fig.10).
- Insert the new V-nail stick(of desired height) into the magazine
- Move forward the claw pusher by flipping the control lever (see figure 6).
- Insert the new size V-nail guide head to match the V-nails to be used (see fig. 11).
- Tighten the locking screw of the V-nail guide head (see fig.8).



Figure 8

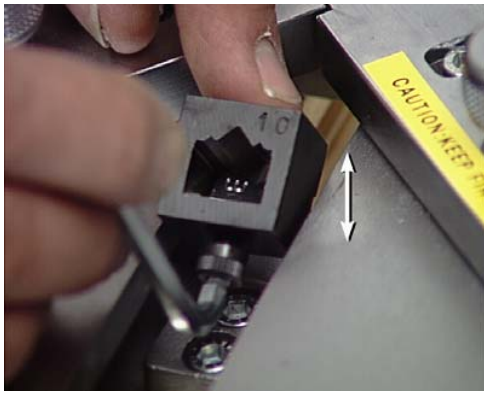

Figure 9



Figure 10



Figure 11

4.9 ADJUSTMENTS

Seeing as the machine was tested before shipping, the operator has only to execute the following adjustments:

4.9.1 Adjustments for v-nails positioning

The Mitre-Mite VN 4 Memory Program is equipped with a V-nail driver mounted on a movable carriage. This is controlled by an electric motor able to fix with extreme precision each V-nail inserting position.

The maximum carriage stroke is 5.7". Within this stroke you can define several inserting positions. These different points are settled on the program that the operator must input for each working cycle.

For further information regarding the programs creation and V-nails inserting positions see chapter 6.

4.9.2 VERTICAL CLAMP ADJUSTMENT

To guarantee perfect clamping of the mouldings throughout the several working cycles the machine is equipped with a double hydraulic clamp. It allows the adjustment of both position and height.

4.9.2.A Vertical clamp position adjustment

- Position on the working bench the moulding to be assembled
- Loosen the (B) handles (see fig 12)
- Shift the cylinders, by sliding them along the cross-bar.
- Position the cylinders directly over the moulding to be assembled.
- Tighten the "B" handles (see fig. 12)
- Loosen the "A" handles (see fig. 12)
- From the execution menù press key F5
- Tighten the "A" handles (see fig. 12)

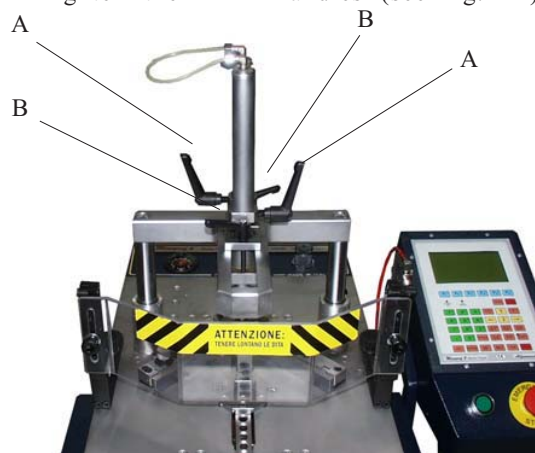

Picture 12

4.9.2.B Vertical clamp height adjustment

Proceed as follows, in order to adjust the vertical clamp height:

- unscrew by using a 6mm allen wrench the "C" screw of picture 4.9.2.B
- lift or lower the vertical clamp
- tighten the "C" screw of picture 4.9.2.B

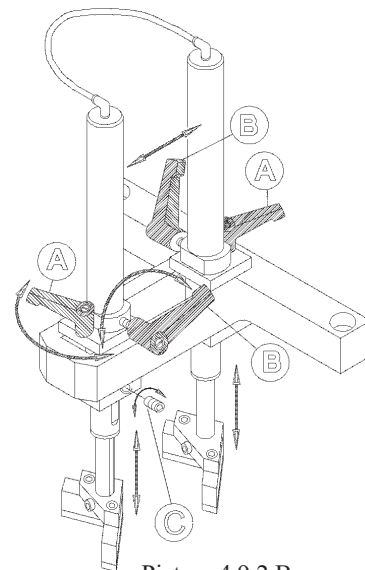

Picture 4.9.2.B

4.9.3 Frontal clamp adjustment

The Front Clamp bar has a series of holes in it. By lifting the bar you can move it from its initial position and reposition it forward or backward.

To lock the bar it is sufficient to insert it into the proper peg in the center of the guide channel.

To properly position the Horizontal Clamp, operate as follows:

1. lift the bar from its peg about 10 - 15 mm and move it forward until reaching the moulding to be assembled;
2. lower the bar & allow it to drop over the peg to lock it in the new position.

	In case of continued use without removing the bar from its position, it is possible to fix it to the peg using the proper screws. In case of shipment, we suggest to clamp the bar by using the supplied screw knob.
---	--

4.9.4 Fence adjustment

The machine is equipped with a special fence composed of 2 different parts.

Each fence side is equipped with a knob that allows it to tilt the moulding supports.

This fence use is recommended to assemble highly profiled mouldings.

Furthermore, if the moulding rolls forward or backwards as the front clamps engages, you can adjust the tilting fence to compensate the effect.

In addition to 90 degrees junctions, the Mitre-Mite VN 4 Memory Program can be used also for 6-sided (120 degrees) or 8-sided frames (135 degrees), by properly positioning the back fence supports.

Proceed as follows to modify the position of back fence supports:

- use a 5 mm Allen wrench and remove the outside screw on the fence parts
- loosen the inside screw slightly and position the fence in the corresponding tapped holes located on the working area.

The proper positioning of the back supports can be obtained by using a special template, which is included with the machine.

Care must be taken to ensure that the 120° or 135° angle is perfectly centered on the internal vertex of the V-nail head. Use the center line of the template to do this.

4.9.5 Working pressure adjustment

The working pressure must be adjusted to the hardness of the mouldings to be assembled.

The pressure regulation permits you to change the clamping pressure of mouldings to be assembled.

Too high of a working pressure can cause a poor junction and (especially on small-size frames) the mouldings can be crushed.

Too low of a working pressure can cause an incomplete insertion of the V-nails into the frame.

The working pressure is adjusted by means of the regulator on the panel near the pressure gauge (see fig. 13).

Proceed as follows to adjust the working pressure:

1. Pull up the regulator cap about 3÷4 mm to unlock it
2. Turn it clockwise to increase the pressure and counter-clockwise to decrease it.
3. Push the regulator cap back down, to lock it into position

The suggested pressures are:

Soft woods	(samba,.....)	30- 40 PSI
Medium	(ramin,.....)	40 - 60 PSI
Very hard woods	(oak)	60 - 80 PSI

The above listed values apply to 7 and 10 mm high V-nails. Increase the pressure by 10 % for 15 mm high V-nails.

When stacking 2 or more V-nails, increase the working pressure by 10/15 %.

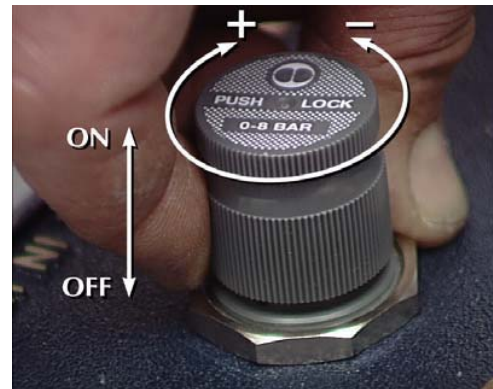



Figure 13

	DO NOT ADJUST the pressure if the machine is not connected to the air supply line.
---	--

4.9.6. Protective shield adjustment

The machine can be ordered with a protective shield made of transparent plastic material. Proceed as follows to adjust the protection shield:

1. loosen the screw knobs fixing the protection and lift or lower it at an height of about 6-8 mm from the mouldings to be assembled;
2. tighten knobs to lock the protection shield.

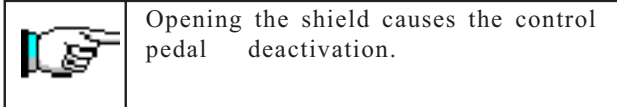

Even if the protective shield is properly adjusted, it is necessary to respect the following instructions:

- keep the fingers away from the frontal and vertical clamp working area
- disconnect the pressure supply during any maintenance intervention
- keep the foot separated from the pedal during the machines adjustments

4.10 OPERATIONS TO BE CHECKED BEFORE STARTING YOUR WORK

Once the machine has been properly installed (like previously described), check that:

- The mouldings to be assembled are properly positioned on the working bench
- The magazine is loaded with the type of nails suitable with the mouldings to be assembled
- The adjustment of vertical and horizontal clamping is correct (chapter 4.9.2 and 4.9.3)
- The machine is connected to the electric network, air and the switches are activated
- The working pressure is adequate to the wood hardness (see chapter 4.9.5)
- The protective shield is properly positioned (see chapter 4.9.6)
- Press the pedal full down to activate the machines cycle

5 FUNCTIONING

5.1 OPERATORS

The machine has been projected to be used by only one operator.

The staff assigned to operate with the machine, must be in possession (or acquire through an adequate training) the requirements indicated here below, and, in addition, to have the knowledge of this handbook and of every information concerning safety:

- General and technical culture sufficient to comprehend this handbook contents and understand properly the drawings and schemes
- Knowledge of sanitary conditions, technological and anti-accidental norms
- Overall knowledge of line and plant where the machine is inserted
- Specific experience frames assembly & working technologies
- To know how operate in case of emergency, where to find the individual protection means and how to use them properly.

The Maintenance person, in addition to the above mentioned characteristics, must be in possession of an adequate technical education.

5.2 CONTROL PANEL

F1 - F6	FUNCTION KEYS
MENU	GO BACK TO THE PREVIOUS MENU
RESET	RE-INITIALIZE THE BOARD
1 - 9	TO INPUT NUMERIC DATA
A - Z	TO INPUT ALPHABETICAL DATA
TC	V-NAILS COUNTER
T	ADJUSTMENT SET
YELLOW KEYS	NAVIGATION KEYS
S1 S4	SPEED SHIFTING TYPE 1 IN EXECUTION
(shift) S1 S4	SPEED SHIFTING TYPE 2 IN EXECUTION
S5	FUTURE APPLICATIONS
SPACE	INSERTION OF EDITING SPACES
SHIFT	ACTIVATION ALPHABETICAL KEYS
DEL	EDITING CHARACTER DELETION
ENTER	DATA CONFIRMATION OR CHOICE
M- M+	DELETE/INSERT POSITIONS
EXE	PROGRAM EXECUTION
STOP	STOP THE MOVEMENTS

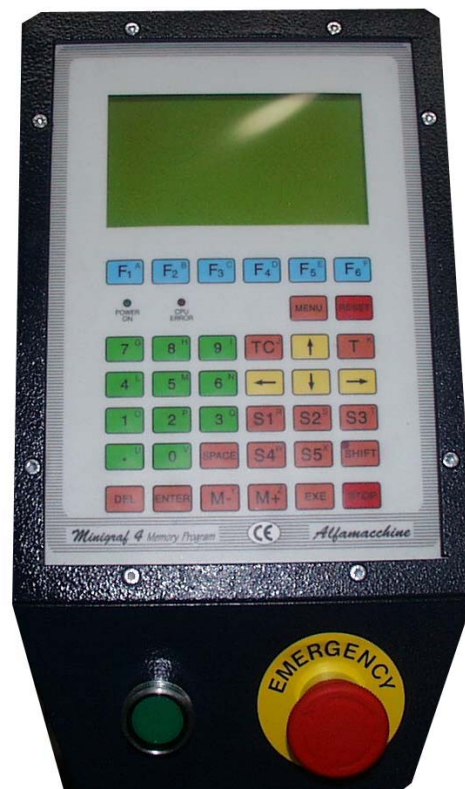

5.3 KEYBOARD CODE/COLORS OF ELECTRONIC CONTROL DEVICE

BLUE keys functions/alphabetical keys

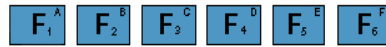

GREEN keys alpha/numerical keys

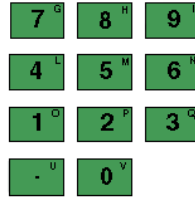

RED keys RESET (re-initialization) keys ; STOP (motor stop)



ORANGE keys EDITING keys (future applications)

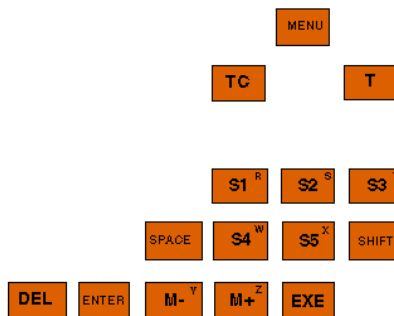

On the keyboard there are 2 diodes:

- One of them is green, labeled POWER ON: when it is turned on it indicates that the machine is electrically supplied
- The other diode, the red one labeled CPU ERROR: when it is turned on it indicates an error of CPU control board. In case it should turn on, try to press on RESET and, if the situation does not improve, contact AMP or your local distributor for assistance.

5.4 MODE OF OPERATION

The Mitre-Mite VN 4 Memory Program allows the operator to create customized working cycles according to size and profile of mouldings to be assembled.

The machine has only one operating mode:

- Semi-automatic operating mode using programs created by the operator

Switching the machine on: the following is displayed on the screen:



Figure 5.4

The icons corresponding to the function keys (F1..F6) have the following meanings:

- F1 Manual Functions (chapter 5.4.1)
- F2 Programming/Executing Functions
- F4 Transferring programs (see page 42)
- F5 Access Enabled
- F6 Parameter Functions

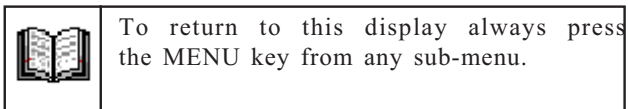

5.4.1 Manual functions menu

Pressing F1 from the main menu allows you access to the Manual Functions sub-menu.

The following functions are available:

- F1 Jog motor it allows you to shift the V-nail driver to the (positive and/or negative side)
- F2 Test Ingressi It allows you to check the proper functioning of the control board inputs
- F3 Output Test It allows you to check the proper functioning of the control board outputs
- F4 Machine zero It takes the V-nail driver back to the homing point (position 0)in the middle of the fences vertex

5.4.2 Jog menu

Entering into the Jog menu (manual movement of V-nail driver) the following picture is displayed:



Press the yellow arrows to move the carriage: <== (toward zero) ==> (toward operator)

The position of the V-nail driver is simultaneously adjusted and displayed on the screen.

This option can be useful to verify visually the V-nails insertion points and record their relevant positions.

Select F1 to confirm or F2 to delete.

5.4.3 Input test menu

Opening the Input Test Menu (checking of inputs proper functioning) the following is displayed on the screen:

Input status is displayed here: only pedal status (enabled / disabled) can be displayed by the operator when the pedal is pressed and released, the other values are only set by authorised technicians.

Input Test	
Pedal	:off
V-Nails inserting	:on
Pressoswitch	:on
Home or min. switch	:off
Sensore di massima	:off
Emergency	:on
Change speed	:off

5.4.4 Output test menu

Opening the Output Test Menu (outputs are tested) the following is displayed on the screen:

Output Test	
Horizontal Block	:off
Vertical Block	:off
Hammer	:off
Buzzer	:on
Free	:off
Free	:off
Free	:off

Use the yellow arrows to position the cursor on the desired option, then press ENTER to activate it and check if it is working properly.



The outputs test works only if the machine has performed the homing cycle at least once before entering into the test.

5.4.5 Machine zero point (homing)

The V-nail driver can be positioned on zero (0) by pressing F4 on the manual functions menu.

	To return to the previous selection always press the MENU key from the sub-menu.
---	--

5.4.6 Editing menu

Pressing F2 then F4 from the main menu allows you to access to the Editing sub-menu.

The following functions are available:

- | | | |
|----|--------|--|
| F1 | Rename | It permits the replacement of the name of a program previously filed |
| F2 | Copy | It allows you to duplicate a program previously filed |
| F3 | Delete | It allows you to delete a program previously filed |
| F4 | Search | It permits a quick search of a code number or name of a program previously memorized |

When you are in this menu, you can also create new programs.

To prevent accidental variations or deletions of the existing programs, the editing service is protected by an access key (password).

To enter into the Editing sub-menu you must type the access code which can be input:

- Before entering into the Editing menu by pressing F5
- After entering into the Editing menu by pressing F5 or F6

On the display you will see the request for the access code : 5678

The icon  indicates that the editing access is enabled

The icon  indicates that the editing access is not enabled.

5.4.7 Rename



Position the cursor on the line corresponding to the program you wish to rename using the yellow arrows, then press F1: type in the new name and confirm it by pressing on ENTER.

	If you wish to use the letters corresponding to the keys, press SHIFT: the diode inserted in the button is lit.
---	---

To disable this option press SHIFT again: the diode goes off.

To delete a wrong entry shift back the <== arrow then press DEL as many times as the number of characters you wish to delete. To add a space press on SPACE.

	To return to the previous selection always press MENU, from the sub-menu.
---	---

5.4.8 Copy



Position the cursor on the line corresponding to the program you wish to copy by using the yellow arrows.

Press F2: use the yellow arrows to move the cursor on a new field, press F1 and digit the new program name (use DEL to delete exceeding characters)

5.4.9 Delete



Position the cursor on the line corresponding to the program you wish to delete by using the yellow arrows, then press F3. You will see a box that says:

Cancellata da: 1 = delete from code # 1

fino a: 1 = delete to code # 1

The first code number Cancellata da...? will be the one that you positioned the cursor on. You must type in the fino a: or delete to code number. This will be the code number you want to set as the final one to delete. Then confirm it by pressing ENTER.

5.4.10 Search

Pressing the F4 key, appears 3 searching sub-groups represented by F1, F2, & F3 keys.

F1 Allows you to search the name of the program.

F2 Allows you to search the code (step) of the program.

F3 Permits the access to the first free programming step.

5.4.11 Creation of new programs

To create a new frame program, perform the following steps: From the main menu press F2, then press F4.

Press F5 or F6 & type in the editing password 5678.

Position the cursor on a free program code line.

Type in the new program name & press ENTER

	If you wish to use the letters instead of numbers, press SHIFT & the letters to be inserted.
---	--

At this point the following screen is displayed:

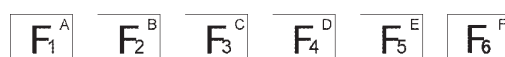
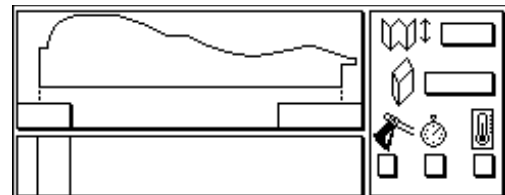

The F1 ÷ F6 keys are enabled to perform the following functions:

- F1 Specifies the height of V-nails to be used in the program
- F2 Specifies the sharpening of V-nails to be used in the program
- F3 Specifies the hardness of material to be used in the program
- F4 Specifies the width of the moulding, (not including the rabbit) in mm .
- F5 Position self-learning
- F6 Definition of running speed to be used in the program

- Press F1, the cursor blinks on the V-nail height field: Type the height of the v-nails in mm;
- Press F2, the cursor blinks on the V-nail sharpening field: type the sharpening to be used (SW, MW etc.);
- Press F3: the screen is updated and the following table is displayed:

Codice	Materiali
> 1	> Very Soft
2	Soft
3	Medium
4	Hard
5	Very Hard
6	Plastic

Use the yellow arrows to move along the table and, once the type of material is selected, press ENTER.

- Press F4, the cursor blinks on the frame profile width: type in the size in mm then press ENTER.
- * Press F6, the following table is displayed on the screen:

Codice	Speed
> 1	> Speed slow 001
2	Speed slow 002
3	Speed normal 001
4	Speed normal 002
5	Speed fast 001
6	Speed fast 002
7	Speed extra fast 001
8	Speed extra fast 002

Use the arrows to move along the table and , once the running speed is selected, press ENTER or F1 to confirm it or F2 to delete it & use the default value.



The working speed value will go to the default if you decide not to change it. See default parameters in chapt. 5.4.15.a

Once the above mentioned data are all entered, the program needs to know the values corresponding to the inserting positions and the number of V-nails that have to be driven for each position (max.9).

Two possibilities are available:

1. self-learning mode (F5) see chapt. 5.4.11.a
2. insertion mode. see chapt.5.4.11.b

5.4.11.a F5 Self-learning

Pressing F5 , the following picture is displayed on the screen:

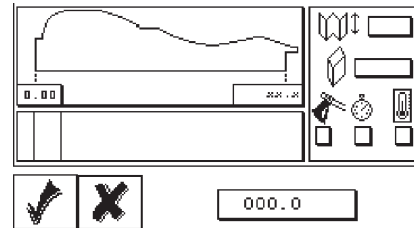

use the yellow arrows <== ==>to move the V-nail driver to the desired point, and check the value on the bottom of the screen; press ENTER when you reach the desired position; on the table below in the frame picture the chosen value is shown and the user is prompted to digit the number of V-nails he wants to insert in that point:

press F5 again to program possible new positions, then repeat the above mentioned procedure, or press the MENU key to exit and save.

NOTE: When the V-nail driver is positioning, F1 can be used instead of ENTER to confirm, otherwise press F2 to cancel.

5.4.11.b Insertion

Use the yellow arrows to move to the position 1 of the inserting point management:

Type the value in mm of the distance from the external vertex of the mouldings to be assembled - then press ENTER;

the cursor shifts on the V-nail number programming side: type the amount of V-nails you wish to insert in the just defined position (max. nine V-nails per position) then press ENTER;

The cursor will position automatically on the next value: repeat the above mentioned steps to add further insertion points.

To switch back to the program list press the MENU key. Press MENU again to return to the main menu.

If one of the critical data to run the cycle is missing a message appears on the screen asking the user to either enter the missing data or terminate the program definition, in which case the program will be considered as incomplete.

5.4.12 Execution menu

Pressing the F2 key you enter into the program execution mode.

A list of the previously stored programs is displayed on the screen:

Codice	Sigla sequenza
> 1	> Nome_Programma
> 2	> Nome_Programma
> 3	> Nome_Programma
> 4	> Nome_Programma
> 5	> Nome_Programma
> 6	> Nome_Programma
> 7	> Nome_Programma

Pressing the F2 key displays the editing window of the selected program to allow its consultation or modification. Pressing the F3 key gives you access to search for a program name or code just like it describes in chapter 5.4.10.

By pressing F4 you enter into the editing mode.

Typing in a new code name on a free code line, you enter into the program creation mode.



Press the Menu button to go back to the execution menu.

Use the yellow arrows to position the cursor on the program to be executed, then press ENTER or F1 to select it.

Press F1 again to obtain the machines zero point.

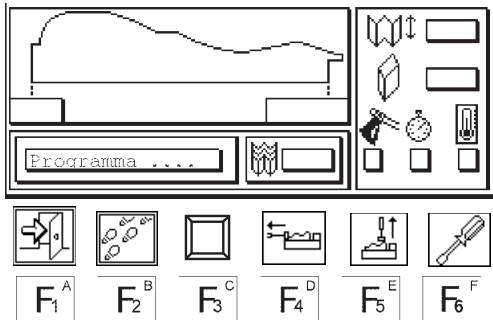
At this point the following screen appears:



- F1  Allows you to go back to the previous menu and exit from the execution mode.
- F2  Permits the access to the step by step execution mode
- F3  Shows the type of current frame and allows its modification by using 3 different types of frames:
 - 4 sided frames
 - 6 sided frames
 - 8 sided frames

F4  Activates the horizontal clamp

F5  Activates the vertical clamp

F6  Ativates the driver head to move to the maintenance position. Pressing the F6 button allows you to activate the drive blade.

Press the F5 key (icon)  to activate the driver blade, while holding down the foot pedal.



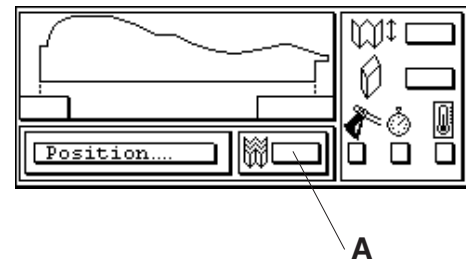

Pressing the F6 button will allow the v-nail head to re-position itself to it's start position. The program goes back to the previous execution menu.

The field "A" indicates the amount of V-nails still available in the magazine. (see chapter 4)



Pressing the F2 key makes it possible to execute a step by step test cycle of the selected program.

At this point the following buttons are activated:

- F1  Go back to the main execution menu
- F2  Negative shifting of the driver blade
- F3  Positive shifting of the driver blade
- F4  V-nail drives (only if the foot pedal is pressed)

To execute a manual test cycle:
Place the mouldings on the machine. Adjust the vertical and the horizontal clamps (See Chapter 4.9.2 and 4.9.3);

1. Press the foot pedal to lock the mouldings and hold it down;
2. Press the F4 key to insert one V-nail. Press it again so the driver blade goes down. If you want more v-nails, repeat the process.
3. Press the F3 key to position the driver on the next insertion point, then repeat step 3
4. Repeat steps 2 and 3 until the icon of the F3 key changes: this means that there are no further programmed points. The same applies to the F2 key whose icon means that no insertion points have been programmed prior to the one in which the V-nail driver is currently positioned.
5. The drivers current position is displayed on the bottom left side of the screen, under the frame outline.

	In the step-by-step mode, the various firing positions can be chosen even if the moulding is not clamped, but V-nails can only be fired (F4 if the foot-pedal is pressed, and the mouldings are safely clamped.
---	---

Press F1 to go back to the main execution menu. After pressing F1 the V-nail driver will automatically go to the first programmed insertion position.

When you are in the main execution menu operate as follows:

1. Place the moldings onto the machine and adjust the vertical horizontal clamps (See Chapter 4.9.2 and 4.9.3).
2. Press the foot pedal to obtain a complete working cycle; release the pedal once the cycle is completed to disable the vertical and the horizontal clamps. This will also reposition the V-nail driver on the first insertion point of the programmed sequence.

Press F1 to go back to the previous menu.

In the program execution screen the following functions are activated:

TC KEY: visualizes the machines production data.
V-nails daily consumption: resettable by pressing F1

V-nails total consumption
Frames production
Rectangular frames production resettable by pressing F3
Hexagonal frames production resettable by pressing F4
Octagonal frames production resettable by pressing F5

Press the Menu key to go back to the previous screen.

T KEY: Allows the adjustment of the vertical clamping times with respect to the current speed during the working cycle.

	The T-key is activated only when you use the access code 1234
---	---

5.4.13 Working speed modification

To modify the working speed use the keys S1.....S4 or SHIFT+S1.....SHIFT+S4.

Available are 8 different speed levels:

- S1 slow speed 1
- S2 slow speed 2
- S3 normal speed 1
- S4 normal speed 2
- S5 fast speed 1
- S6 fast speed 2
- S7 extra fast speed 1
- S8 extra fast speed 2

Once the speed level is selected, confirm it by pressing ENTER.

	The operator has the possibility of changing the working speed while the machine is running by using the keys S1...S4 or (shift). S1...S4 is enabled by a password parameter. This option will be agreed upon during the contractual phase and pre-disposed on the machine at its origin.
---	---

5.4.14 Enabling access code protected services

The F5 key on the main menu (see figure 5.4) allows the operator to enable some access code protected submenus.

Its graphic representation shows the inserted access level.

Such menus are:

- Parameter Menu F6
- Editing Menu F2

Default access keys are:



Parameters (speed delays) 1234
Editing 5678
Reset counter 9999

These keys can be modified with the help of authorized staff.

	If you set the Edit password to "0", the editing password will no longer be asked for.
---	--

To enable the codes proceed as follows:
Press the F5 button from the main menu and when the request message appears, insert the code.

5.4.15 Machine parameters

The F6 key corresponds to the icon  of the main menu & gives you access to the machine configuration parameters menu. To access all functions in this menu you will need the main installation password. You must call AMP to get it. After entering into the parameters menu the icons will change places. The operator can access only 2 levels of the parameters corresponding to the F6 icon  & the F5 icon 

5.4.15.A. F5 KEY

The F5 key (corresponding to the icon  is relative to the CUSTOM parameters.

The access is possible by:

* 9999 code

The machine code : A (machine identification code for serial communication through the RS232 connector)

The language can be selected according to the following codes:

- * 0 Italian
- * 1 French
- * 2 English
- * 3 German

Power supply: power supplying Voltage (%)

Default speed: proposed speed for programs creation

Homing/ zero any cycle : input of machine zero point every time the program is executed (si=yes)

Pedal vertical/horizontal clamping: pre-disposition of clamping when the cycle is ended depending from the pedal (no)

Maintenance: driver head maintenance position (100 = 100mm)

V-nails: Qty of V-nails per strip (200)

V-nails reserve: minimum Qty of V-nails that starts the machine alarm (10)

Change speed: permits you to change the operating speed while the machine is running (yes)

Frames min/max limit: these are the min/max values where the assembly will stop. The max value refers to the size of programmed frame

Type of frame: displays the option regarding the chosen type of frame to count the production (si= yes)

5.4.15.B F6 key

F6 key corresponds to the  icon: speed parameters; (access code 1234). It allows you access to the tables of machine speed/times for each listed assembling speed.

	We suggest: you do not modify the times relative to the speed if not assisted by a qualified technician. The time delays have been calculated during the machines testing.
---	--

It is possible at any moment, if the data should be altered, to restore the typical data input by the producer, by pressing F1 and confirming it by pressing ENTER

5.5 FRAMES PRODUCTION AND V-NAILS CONSUMPTION

The machine is equipped with a total and daily V-nail counter.

To access to the counters press the TC button.

DailyV-nails	:	XXXX
Total V-nails	:	XXXX
Rectangular	:	XXXX
Hexagonal	:	XXXX
Octagonal	:	XXXX

	The daily V-nail counter can be reset by pressing the key F1
---	--

5.6 TIPS FOR PERFECT JUNCTIONS

a) V-nail types

In order to allow the machine to make excellent quality junctions using different materials, it has been necessary to manufacture different V-nails types for different uses.

V-nails can be classified in three different groups:

for soft woods and soft plastic	Suggested V-nail code SPT
for medium woods	Suggested V-nail code HPT
for hard woods	Suggested V-nail code HPT

Note: you can also order v-nails for horizontal grain MDF Suggested V-Nail Code: HDF

b) Assembling positions

It is advisable to operate as follows in order to achieve the best results in terms of junction quality:

- Never drive V-nails near the junction vertex. The minimum recommended distance from the external vertex is at least 10 mm.
- When you want to make the junction using only one V-nail, the most suitable position is in the center of the moulding.
- In case you want to insert 2 or more V-nails into each junction, we recommend you to insert the most external one $1/3$ from the external vertex and the most internal one $1/4$ from the internal vertex.

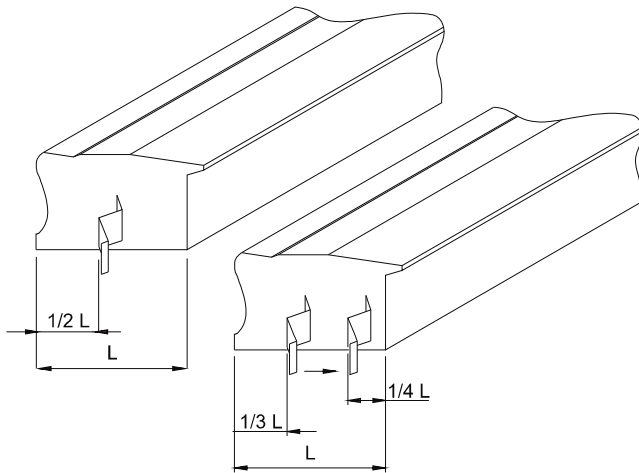

5.7 MACHINE STOP

The machine can work only by pressing the electric pedal; to stop it mid-cycle press the red emergency stop button on the keypad.

It is possible also to disconnect the fast clutch fitting from the compressed air or isolate electrically the machine by the special switch located on the floor stand.



5.8 PUTTING OUT OF SERVICE

In case on long inactivity periods it is necessary to disconnect the fast clutch fitting from pneumatic system and the power supply cable.

6. PROGRAMMING

6.1 CREATION OF A PROGRAM

To program a frame, operate as follows:
From the Main Menu



Figure 6.1.A

- Press F5
- Type the access code 5678
- Press F2 (writing frame program icon)
- Position with the cursor on an empty line/code, then press enter
- Type the new program name

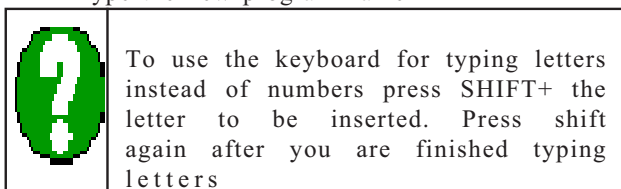

- Press ENTER

At this point the following screen is displayed:

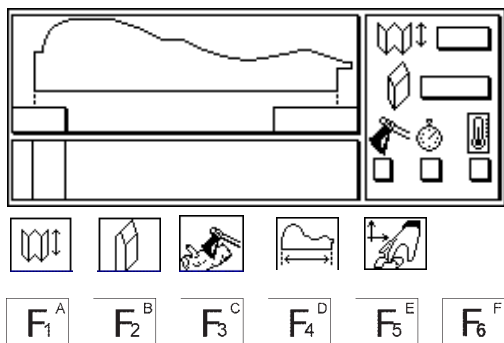

- Press F1
- Type in the V-nail height
- Press ENTER
- Press F2
- Type in the V-nails sharpening
- Press ENTER
- Press F3
- Type in the value corresponding to the hardness of material to be assembled (see chapter 5.4.11)
- Press ENTER
- Press F4
- Type in the width of the moulding in(mm)
- Press ENTER
- Press F6
- Enter in the value of the working speed (see chapter 5.4.11) by using the directional arrows

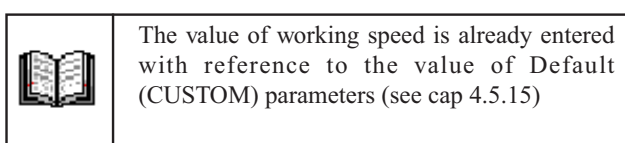

- Press ENTER
- Positioning the V-nail head. This operation can be done in 2 ways:
- Auto-learning mode
- Inputting mode

6.1.A. Auto-learning mode

- Press F5

The following screen appears:

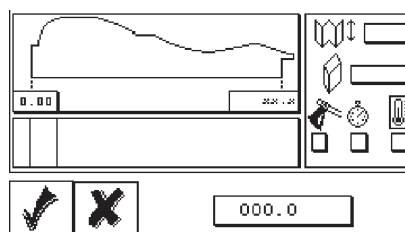

- Execute the v-nails head positioning by the directional arrows
- Press ENTER
- Type in the number of V-nails to be inserted
- Press ENTER
- Repeat the above steps for each V-nail inserting position

6.1.B Inputting mode

- Position the cursor (A) on the V-nails inserting positions to be programmed (B) - see the fig. 6.1.B.
- Type in the value in mm.
- press ENTER
- Type in the number of V-nails to be inserted
- Press ENTER
- Repeat the above steps for each V-nail inserting position

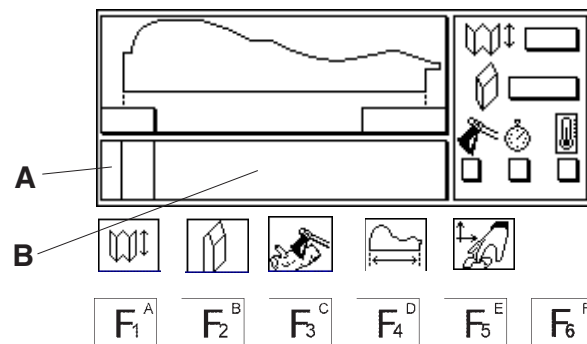
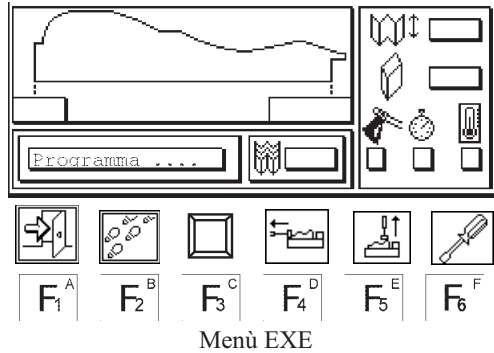

Figure 6.1.B

7. EXECUTION OF THE PROGRAM



7.1 EXECUTION OF A PROGRAM YOU JUST ENTERED

Turn on the machine by the switch placed on the floor stand (position it to MOTOR ON).

On the edited program (see chapter 6.1) press EXE key, then press ENTER to confirm the selection (press F2 to cancel it).

On the screen is displayed the request of Homing:

- Press ENTER to confirm the Homing
- Press F2 to cancel the request

Press on the foot pedal for inserting the V-nails.

7.2 EXECUTION OF A PROGRAM PREVIOUSLY MEMORIZED

Turn on the machine by the switch placed on the floor stand (position it to MOTOR ON).

On the screen is displayed the fig. 6.1.A.

Press the EXE key.

Selected the chosen program by using the directional arrows or by the F3 key.

Press ENTER.

Press on the foot pedal for inserting the V-nails.

7.3 MACHINE ADJUSTMENT

Run the program execution (see chapters 7.1 and 7.2).

Press F4 to activate the horizontal clamping.

Press F5 to activate the vertical clamping.

Press F2 and then F3 to execute the V-nail head step by step shifting

Press the foot pedal and F4 to fire the V-nail

Press F1 to go back to the Execution menu.

8. MAINTENANCE

8.1 STATE OF MAINTENANCE

The maintenance operations must be performed with the machine in the conditions described at the paragraph “state of the machine” in the tables 8.6 and 8.7.

	<p>Press the F6 button. This will position the driver head to the maintenance position. Press the F5 button to test the driving of v-nails while in the maintenance mode.</p>
---	---

8.2 MACHINE ISOLATION

Before performing any type of maintenance or repair , it is necessary to isolate the machine from the feeding sources, making the following operations:

- 1) Disconnect the plug from the electric socket.
- 2) Disconnect the fast clutch fitting from the pneumatic system.

8.3 SPECIAL CAUTIONS

During the maintenance or repair operations we suggested to proceed as follows:

- Before starting any operation place a sign-board “machine under maintenance” in a well visible position
- Do not use solvents or flammable materials
- Do not step on the machine parts, because they have not been projected to sustain the weight of persons.
- Disconnect the power supply from the electric system & disconnect the air supply
- Once all the operations are finished, restore and place properly the protections and shields removed or opened

8.4 CLEANING

The machine structure is simple and robust therefore the mechanical parts do not require any special maintenance.

It is recommended that you follow the rules listed here below:

- Regularly remove glue or other residues from the V-nail head and from the upper part of the driver blade;
- always keep the V-nails magazine clean
- remove any residue from the V-nail guide “L” shaped support.

Do not use water to clean the machine, otherwise the metallic parts may oxidise.

	<p>Before performing any cleaning intervention, the operator must disconnect the electric and the pneumatic systems.</p>
---	--

8.5 LUBRICATION

	<p>If you use glue when joining frames, we suggest you lubricate the driver blade daily.</p>
---	--

Fill your lubricator with oil, use CASTROL MAGNA GC 32 or equivalent oil. Do not use oil with heavy cleaners in it.

Furthermore, we recommend you lubricate the driver blade every 200 working hours.

ATTENTION: Unsuitable lubricants may cause valve seal problems (seals may become too large) and consequent Valve jamming.

8.6 ORDINARY MAINTENANCE

The following operations must be executed on the times indicated here below. Not observing the following instructions exonerate the Producer from any responsibility regarding the warranty.

The operations described here below, even if simple, must be executed by qualified personnel.

The scheduled ordinary maintenance includes overhauls, checks and interventions that, to prevent stops and breakdowns, keep under systematic control:

- Lubrication state of the machine
- Wear and tear parts state

Table 8.6

Maintenance	Description	Machine state
V-nail driver blade	Replacement every 1.000.000 V-nails shot	Isolation for maintenance
Movable parts lubrication	Lubricate the driver blade every 200 working hours	Isolation for maintenance
V-nails claw heads	Replacement every 5.000.000 V-nails shot	Isolation for maintenance
“L” shaped supports (V-nails guide)	Replacement every 5.000.000 V-nails shot	Isolation for maintenance

8.7 EXTRAORDINARY MAINTENANCE

We have listed below the operations that need the intervention of ITW/AMP's or your local distributor's Technical Assistance (see the paragraph 1.2) or by qualified staff authorized by the Producer

The extraordinary maintenance includes interventions to be performed in exceptional cases:

- Breakage
- Revisions

TAB. 8.7

MAINTENANCE	DESCRIPTION	MACHINE STATE
Valves and Reducers	Suggested replacement every 6/8 million of V-nails shot	Isolation for maintenance
Frontal and vertical clamping gaskets	Replacement in case of leak of air	Isolation for maintenance

9. DIAGNOSTIC

9.1 SAFETY WARNINGS

The following interventions must be performed by personnel properly trained and you must take all precautions in order to avoid accidental starts.

9.2 BREAKDOWN SEARCH

Functional inconveniences (causes/remedies)

9.2.a Pressing the foot pedal the v-nail does not drive normally

Possible cause	Remedy
Insufficient working pressure	<ul style="list-style-type: none"> The minimum value should be higher than 4 Bar
v-nails positioned wrong into the magazine	<ul style="list-style-type: none"> The sharpened side (glued side) must be facing up The V vertex of nails must face the machines rear side
Insufficient pressure on the V-nail feed cylinder	<ul style="list-style-type: none"> The regulator pressure must be at least 2 bars. If necessary increase it 10%.
Claw head not suitable with V-nails height	<ul style="list-style-type: none"> The number engraved on the claw head must correspond to the V-nails height
Defective V-nails	<ul style="list-style-type: none"> Replace the V-nails

9.2.b Pressing the foot pedal the machine does not work

Possible cause	Remedy
Insufficient working pressure	<ul style="list-style-type: none"> The air pressure coming out from the compressor must be at least 3 Bars
V-nail magazine open	<ul style="list-style-type: none"> Close the magazine by flipping the special valve

9.2.c After several cycles the machine becomes irregular

Possible cause	Remedy
Jammed valves because of water or oil surplus	<ul style="list-style-type: none"> Eliminate the water or oil surplus by disconnecting one by one the control pipes to make the air pressure force out the water or oil
Defective valves	<ul style="list-style-type: none"> Replace the control valves

9.2.d Pressing the electric pedal the machine does not work

Possible cause	Remedy
There is no air in the pneumatic syst	<ul style="list-style-type: none"> Verify that the compressor is running and the drains are closed
There is no power	<ul style="list-style-type: none"> Verify that the main switch is turned on and the machine is connected with the electric network If the machine is connected and there is power verify that “power on” diode is turned on

9.2.e The electronic part does not work

Possible cause	Remedy
Machine disconnected from the electric network or one or more interrupted fuses	<ul style="list-style-type: none"> • Connect the machine with the electric network • Unscrew the panel located on the rear side of the doorstand: verify by using a tester the fuses continuity and replace it if necessary <ol style="list-style-type: none"> 1. Network filter board M003/x: delayed 4A fuse (mod. 5x20 glass) 2. Board M021/x...F1 delayed 10A fuse (mod. 5x20 glass) 3. F2 delayed 6,3A fuse (mod. 5x20 glass)
Wrong voltage	<ul style="list-style-type: none"> • connect the machine to a 120 V socket
If the above listed conditions are correct and the failure still exists <ul style="list-style-type: none"> • call AMP or your local distributor's Assistance service 	

9.2.f Wishing to insert several V-nails one upon the other in the same point, they do not stack properly or tilt during their insertion

Possible cause	Remedy
Wrong V-nails	<ul style="list-style-type: none"> • replace the V-nails with the proper ones
Improper clamping, (the frame moves during the insertion of V-nails)	<ul style="list-style-type: none"> • verify and if necessary adjust the vertical and horizontal clamps positions • increase the pressure by using the regulator

9.3 REQUEST OF ASSISTANCE

For any information regarding Use, Maintenance, Installation, etc.. We remain at your disposal. The Customer has to formulate clearly the questions. Call or Send us a detailed fax about the nature of the problems. For eventual explanations we recommend you make reference to this handbook and to the instructions listed in the paragraph 1.2.

www.fletcher-amp.com
 Phone: 1-800-322-4204
FAX: 1-800-426-7019
 E-Mail: customerservice@fletcher-amp.com

10. SPARE PARTS

10.1 SPARE PARTS LIST

Even if the machine has been submitted to several tests and functional checks, we list here below the components and relative amounts (in brackets) that we suggest to have a minimum and sufficient set of spare parts to guarantee the least amount of down time as possible.

COMPONENT
V-NAILS DRIVER BLADE V-NAILS CLAW HEADS “L” SHAPED SUPPORT (V-NAILS GUIDE) VALVES-REDUCERS-REGULATORS VERTICAL AND HORIZONTAL CLAMPING GASKETS

10.2 SPARE PARTS ORDERING

We remind you that only a qualified technician can repair the machine.

Thus, we suggest the intervention of AMP's or your local distributor's Center of Technical Assistance, which has the qualified staff, proper equipment and tools, and uses original spare parts.

To order the spare parts listed above, send by fax or letter (see chapter 7.3) the following data:

- Model of the Machine
- Code of mechanical drawing
- Reference number of spare part or group indicated on the mechanic drawing
- Code/part number of single or group spare part

11. DEMOLITION

11.1 DEMOLITION

At the act of demolition it is necessary to separate the parts in plastic material from electric components. Most countries require this, respecting the current Norms.

Concerning the machine metallic mass, it is enough the subdivision between the steel parts and those of other metals or alloys, for a proper recycling by smelting.

12. ATTACHMENTS

12.1 DECLARATIONS

You can find here attached the following declarations:

- Declaration of conformity to the Norm 89/392/CEE
- Declaration of conformity to the Norm 89/336/CEE

12.2 SCHEMES

You can find here attached the following schemes:

- (A) Mechanic Schemes
- (B) Pneumatic Scheme
- (C) Plates Dislocation
- (D) Sharpening Table
- (E) Electric Scheme

Memory Program

Disegno DWG Nr. 007.0.100

Rev.1 / 10 - 1997

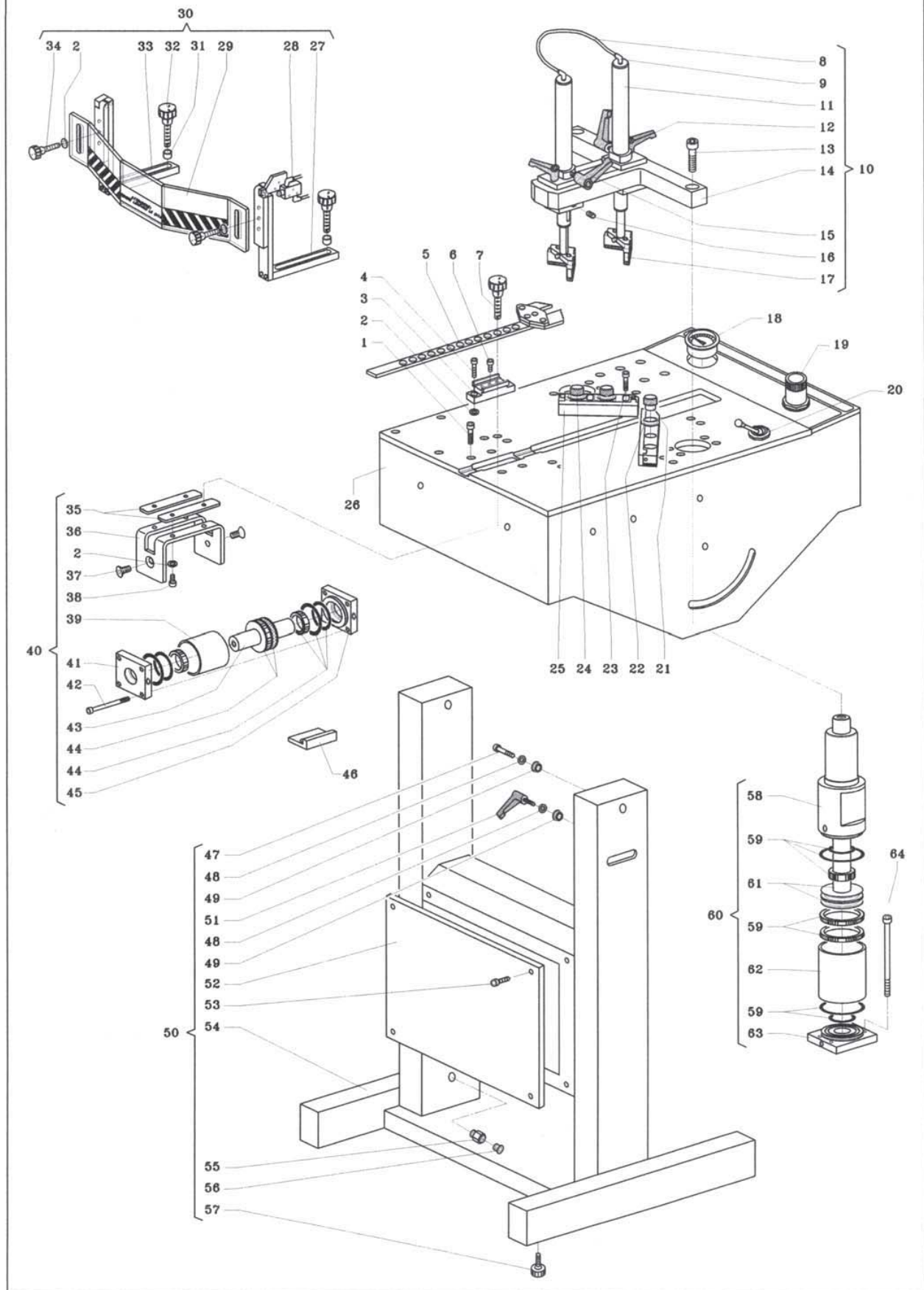

Memory Program

Disegno DWG Nr. 007.0.100

Rev.1 / 10 - 1997

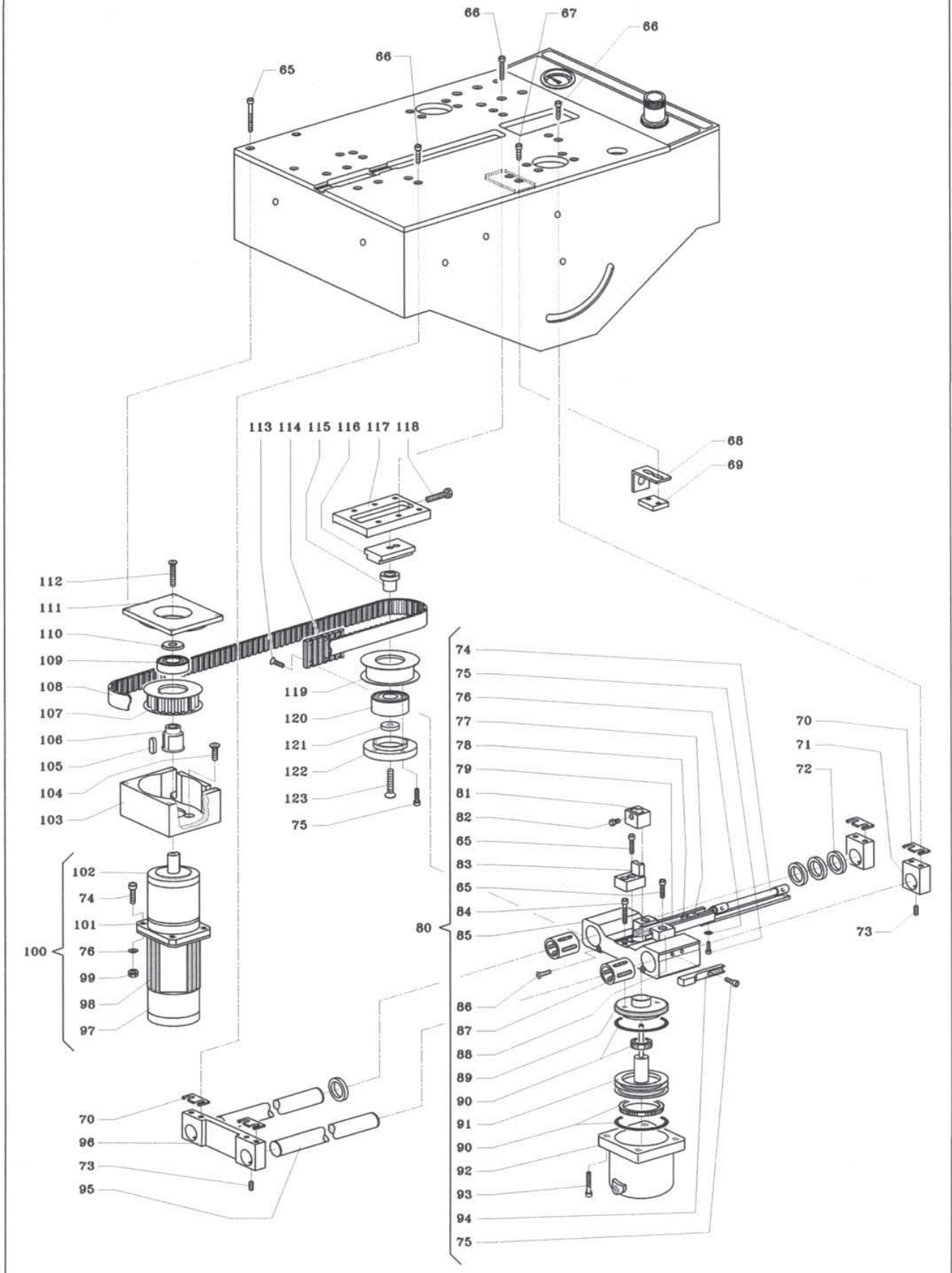

Ref.	Code Number	Qty	Descrizione	Description
1	710100076	4	Vite	Screw
2	718100003	2	Rondella	Washer
3	392750010	1	Supporto	Support
4	710100074	1	Vite	Screw
5	242170100	1	Staffa di bloccaggio	Blocking clamp
6	366210030	1	Vite	Screw
7	753320001	1	Pomello	Knob
8	365110010	1	Tube	Hose
9	730160010	2	Raccordo	Fitting
10	242230090	1	Bloccaggio idraulico completo	Complete hydraulic hold down
11	223130080	1	Cilindro completo	Complete cylinder
12	753170005	2	Maniglia	Handle
13	710100157	2	Vite	Screw
14	376400130	1	Supporto	Support
15	243170010	2	Maniglia	Handle
16	714300042	2	Grano	Set screw
17	242230060	2	Tampone	Pressure plate
18	734230003	1	Manometro	Pressure gauge
19	735630003	1	Regolatore di pressione	Pressure regulator
20	732140001	1	Valvola a leva	Lever-valve
21	336300030	2	Pomello	Knob
22	337500030	3	Distanziale	Spacer
23	710100049	4	Vite	Screw
24	336300060	1	Pomello	Knob
25	243160030	1	Squadra completa	Complete Fence assembly
26	211250190	1	Basamento	Main frame
27	241300020	1	Supporto	Support
28	732540003	1	Valvola	Valve
29	398950030	1	Protezione	Safety shield
30	248950010	1	Protezione completa	Complete safety guard
31	336100020	2	Distanziale	Spacer
32	753320002	2	Pomello	Knob
33	241300010	1	Supporto	Support
34	753320005	2	Pomello	Knob
35	371200010	2	Guide	Guide
36	384400010	1	Supporto	Support
37	710200081	2	Vite	Screw
38	710600002	4	Vite	Screw
39	333500020	1	Canna	Cylinder
40	225120010	1	Cilindro completo	Complete cylinder
41	352200020	1	Testata	Cylinder head
42	710100087	4	Vite	Screw
43	331000030	1	Pistone	Piston
44	298390050	1	Kit guarnizioni	Gasket kit
45	352200030	1	Fondo	End cap
46	384200020	2	Staffa	Bracket
47	710100115	2	Vite	Screw
48	718100004	6	Rondella	Washer
49	336100060	6	Distanziale	Spacer
50	240450100	1	Cavalletto completo	Complete floorstand
51	714300031	1	Grano	Set screw
51	753170003	1	Maniglia	Handle
52	391670030	2	Piastra	Cover
53	710100003	8	Vite	Screw
54	291670080	1	Basamento	Base
55	258210360	2	Valvola scarico condensa completa	Complete drain plug
57	753690010	4	Piede	Levelor
58	352400230	2	Testata	Cylinder head
59	298390070	2	Kit guarnizioni	Gasket kit

<u>Ref.</u>	<u>Code Number</u>	<u>Qty</u>	<u>Descrizione</u>	<u>Description</u>
60	225220031	2	Cilindro completo	Complete hold down cylinder
61	331000190	2	Pistone	Piston
62	333500240	2	Canna	Cylinder sleeve
63	352200210	2	Fondo	End cap
64	701000100	8	Vite	Screw
65	710100079	8	Vite	Screw
66	710100076	14	Vite	Screw
67	710100073	2	Vite	Screw
68	384200010	1	Supporto	Support
69	381300680	1	Supporto	Support
70	381600010	4	Distanziale	Spacer
70	381600020	4	Distanziale	Spacer
70	381600030	4	Distanziale	Spacer
70	381600040	4	Distanziale	Spacer
70	381600050	4	Distanziale	Spacer
71	383900440	2	Supporto	Support
72	336500020	3	Boccola	Bushing
73	714300017	4	Grano	Set screw
74	221330030	1	Cilindro completo	Complete nail feed cylinder
74	710100045	2	Vite	Screw
75	710100042	8	Vite	Screw
76	718100002	2	Rondella	Washer
77	244500010	1	STG perno	Complete pin
78	395450021	1	Pressore graffe	Staple pusher
79	398350030	1	Magazzino graffe	Nail magazine
80	224240130	1	Testa completa	Complete driver assembly
81	394950020	1	Testina H7	7mm nailhead
81	394950030	1	Testina H10	10mm nailhead
81	394950050	1	Testina H15	15mm nailhead
82	710100070	3	Vite	Screw
83	384200050	1	Blocchetto "L"	L - Block
84	710100057	2	Vite	Screw
85	352700040	1	Testa	Head
86	710200041	8	Vite	Screw
87	740550001	4	Cuscinetto	Rod bushing
88	383600020	2	Block	Block
89	352400240	1	Testata	Cylinder head
90	298420060	1	Pistone con martelletto	Piston and driver blade
91	298390041	1	Kit guarnizioni	Gasket kit
92	352200260	1	Cilindro	Cylinder housing
93	710100093	8	Vite	Screw
94	394650010	1	Camma	Cam
95	334000010	2	Guide	Guide
96	383900450	1	Supporto	Support
97	352600050	1	Coperchio	Cover
97	827550001	1	Encoder	Encoder
98	827600001	1	Riduttore	Reduction gear
99	715650002	4	Dado	Nut
100	807650010	1	Motore completo	Complete motor
101	337500260	1	Distanziale	Spacer
102	827650003	1	Motore	Motor
103	381300690	1	Supporto	Support
104	710200043	4	Vite	Screw
105	701350003	1	Linguetta	Key
106	392550010	1	Mozzo	Hub
107	336000110	1	Puleggia motore	Pulley
108	753660006	1	Cinghia	Belt
109	740550008	1	Cuscinetto	Rod bushing
110	336100380	1	Rondella	Washer
111	352600030	1	Coperchio	Cover

<u>Ref.</u>	<u>Code Number</u>	<u>Qty</u>	<u>Descrizione</u>	<u>Description</u>
112	710200046	1	Vite	Screw
113	710200044	4	Vite	Screw
114	397250090	1	Giunto	Connector
115	334500110	1	Perno	Pin
116	384600090	1	Supporto	Support
117	381300070	1	Supporto	Support
118	710600010	1	Vite	Screw
119	336000100	1	Puleggia	Pulley
120	740550009	1	Cuscinetto	Rod bushing
121	336100010	1	Rondella	Washer
122	352600040	1	Coperchio	Cover
123	710200103	1	Vite	Screw

ATTACHMENT B - PNEUMATIC SCHEME

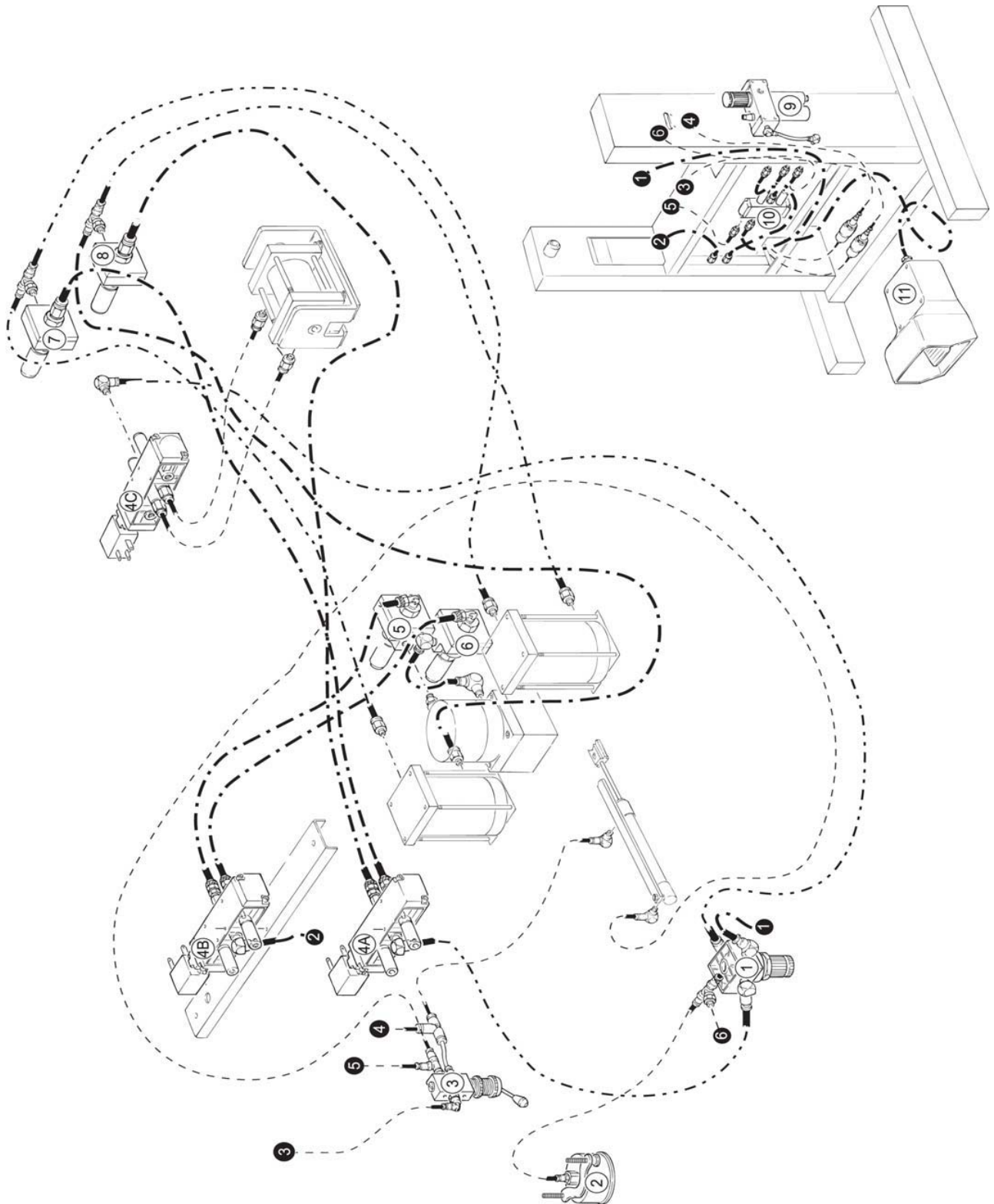

Ref.	Description	Code Number
1	Pressure Regulator	735630003
2	Pressure Gauge	734230003
3	Lever-Valve	732140001
4A	Solenoid Valve	732440023
4B	Solenoid Valve	732440023
4C	Solenoid Valve	732440023

Ref.	Description	Code Number
5	Exhaust Valve	732390003
6	Exhaust Valve	732390003
7	Exhaust Valve	732390003
8	Exhaust Valve	732390003
9	Filter-Lubricator	735330001
10	Valve	732440016
11	Foot pedal	258710020

ATTACHMENT C - PLATES DISLOCATION

CAUTION!
FOR YOUR SECURITY
DISCONNECT THE AIR
SUPPLY BEFORE REPLACING
THE V-NAIL CLAW HEAD OR
ANY MAINTENANCE OPERATION

CAUTION : KEEP FINGERS AWAY



CE
Alfamacchine
Via dell'Artigiano, 12 Forlì ITALY
TYPE Memoryprogram
BUILDING YEAR 1998
SERIAL NUMBER ___ 142 ___
WEIGHT 115 Kg
PNEUMATIC SUPPLYING 6 - 7 BAR

CAUTION :
KEEP FINGERS AWAY

ATTACHMENT D - SHARPENING TABLE

	SOFT WOOD			HARD WOOD		
	A	B	C	D	E	F
<i>Height</i> mm	Very soft wood	Soft wood	Averaged soft wood	Averaged hard wood	Hard wood	Very hard wood
H 3* mm	HPT	HPT	HPT	HPT	HPT	HPT
H 5* mm	HPT	HPT	HPT	HPT	HPT	HPT
H 7 mm	SPT	SPT	HPT	HPT	HPT	HPT
H 10 mm	SPT	SPT	HPT	HPT	HPT	HPT
H 12 mm	SPT	SPT	HPT	HPT	HPT	HPT
H 15 mm	SPT	SPT	HPT	HPT	HPT	HPT

SPT Suitable for soft wood such as: Thailand and Asian South-East wood, Cedar, Pine, Bass, Banak, Obeche, Poplar
Other materials: Cellular, Polystyrene, Vertical Grain MDF

HPT Suitable for soft wood such as: Thailand and Asian South-East wood, Cedar, Pine, Bass, Banak, Obeche, Poplar, polystyrene, pvc

HPT Suitable for soft wood such as: Oak, Ash, Hickory, Pecan, Maple, Cherry, Ramin
Other materials: Horizontal grain MDF

HDF Suitable for horizontal Grain MDF & HDF



In order to stack 2 or more V-nails per junction, use V-nails coded **HPT OR HDF**

ATTACHMENT E - ELECTRIC SCHEME

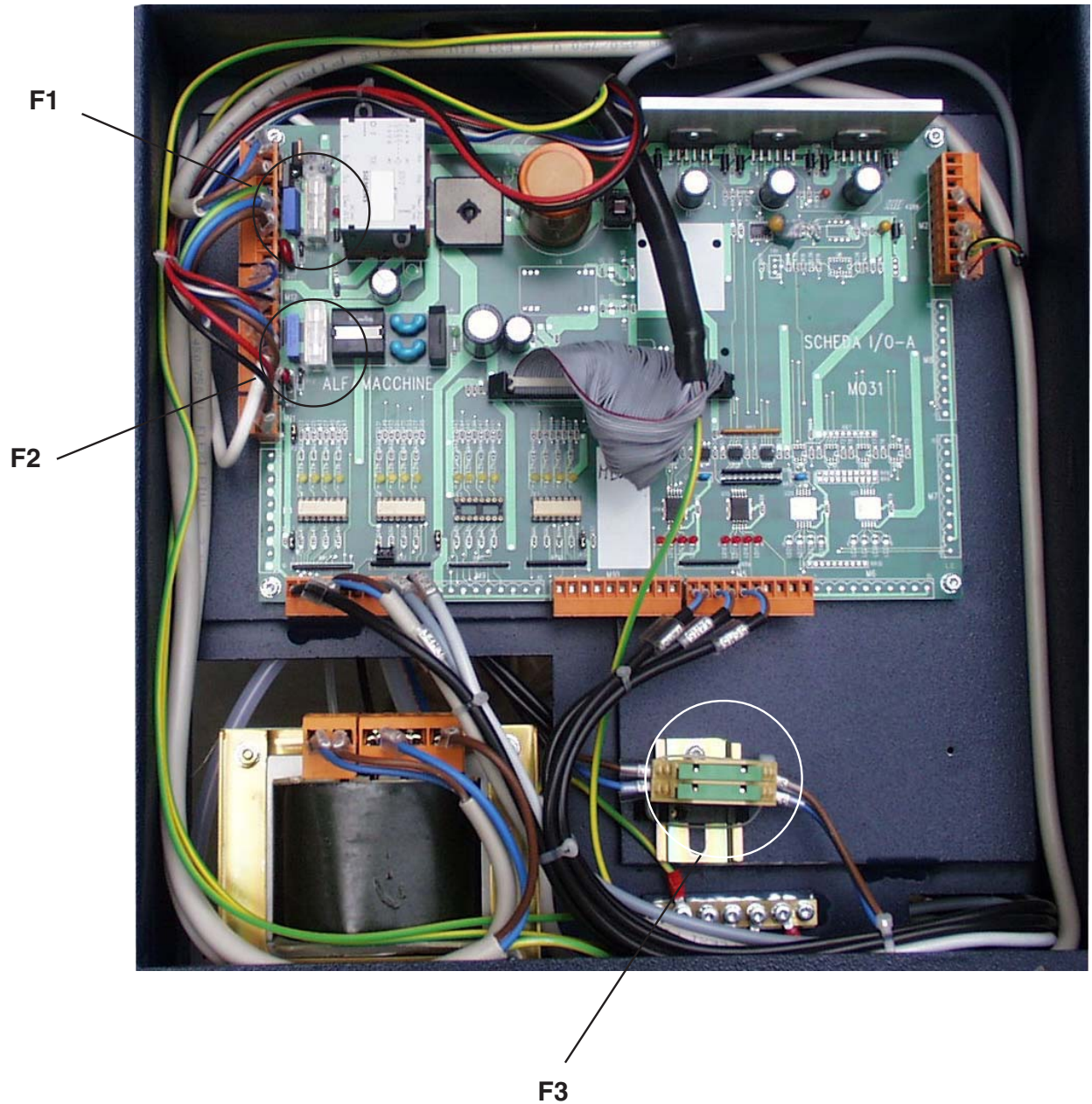

- Fuse F1: 10 A 250 V delayed (type 5x20)
- Fuse F2: 6,3 A 250 V delayed (type 5x20)
- Fuse F3: 3,15 A 250 V delayed (type 5x20)

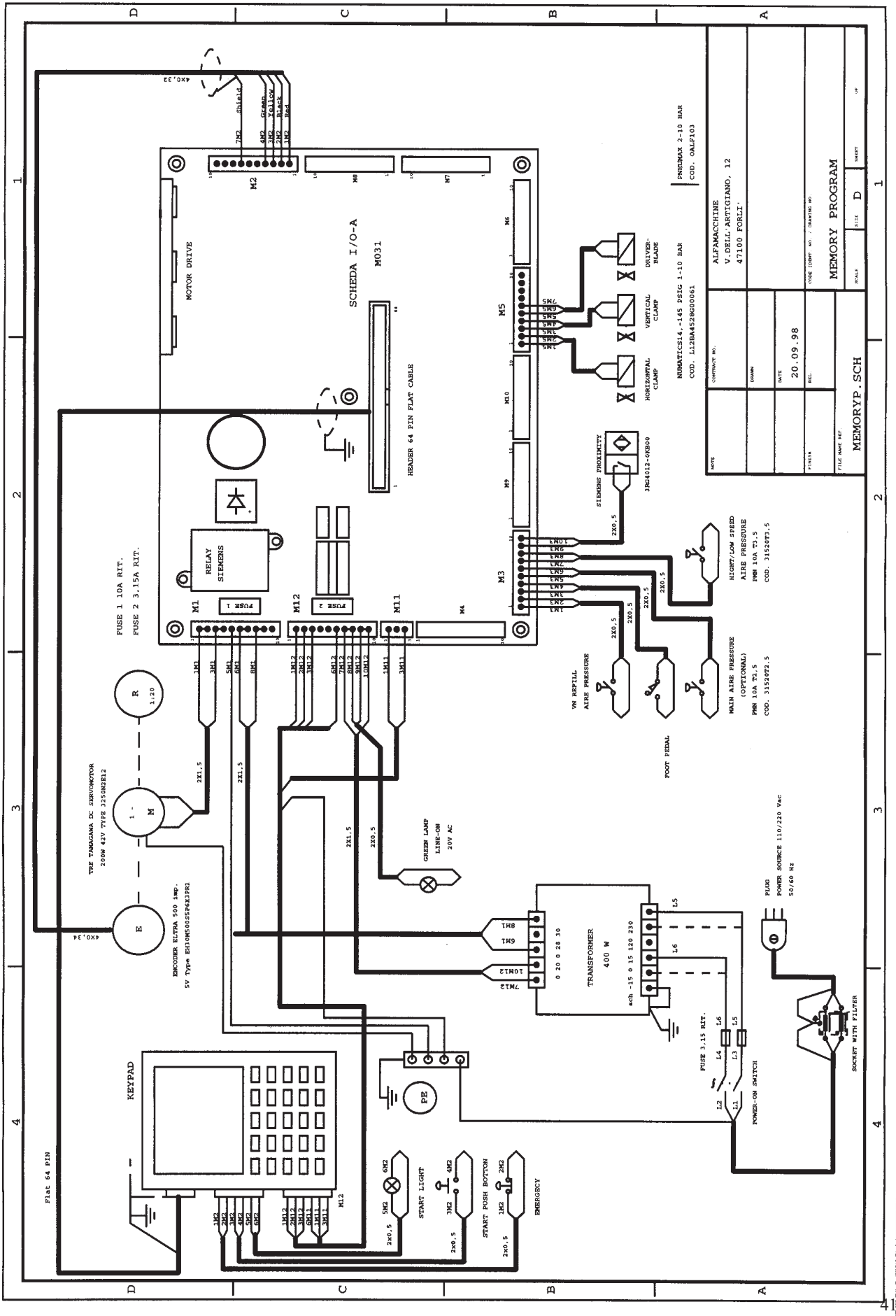

NOTE	ALFAMACCHINE V. DELL'ARTIGIANO, 12 47100 FORLÌ
DATE	20.09.98
FILE NAME	MEMORY P. SCH
SCALE	D
SHIRT	10

INMATIC34, -145 PSIG 1-10 BAR COD. LL2BA452860061	DRIVER- BLADE
SIEMENS PROXIMITY 3RG4012-08B00	HORIZONTAL CLAMP
SIEMENS PROXIMITY 3RG4012-08B00	VERTICAL CLAMP
IN REPTIL AIR PRESSURE	
HIGHT/LOW SPEED AIR PRESSURE (OPTIONAL)	
MAIN AIR PRESSURE (OPTIONAL)	
PMR 10A T2.5 COD. 3152071.5	
PMR 10A T3.5 COD. 3152071.5	

THE TOSHIBA DC SERVO MOTOR 200W 42V TYPE 325202B12	
ENCODER EXTRA 500 RPM. 5V TYPE ED10K055FM421P02	
RELAY SIEMENS	
MOTOR DRIVE	
SCHEDA I/O-A M031	
KEYPAD	
START LIGHT	
START PUSH BUTTON	
EMERGENCY	
PE	
GREEN LAMP LINE-ON 240V AC	
TRANSFORMER 400 W 0 20 0 28 30 400V -15 0 15 120 230	
POWER ON SWITCH FUSE 3.15 RL7. L1 L2 L3 L4 L5 L6	
PLUG POWER SOURCE 110/220 VAC 50/60 HZ	
SOCKET WITH FILTER	

MEMORY PROGRAM	FILE	D
MEMORY P. SCH	SCALE	D
SHIRT		10

UPGRADE - VERSION 5.03

D.1 CODIFY PROGRAMS THROUGH BARCODE

It is possible to program & recall the the frame to be joined using a barcode.
Using a barcode scanner (see picture D.1) the program name is conveyed to the machine



Picture D.1



Use a laser scanner, code number 805500001

The scanner must be connected to the suitable connector “A” (see picture D.1.A) which is placed on the back side of keypad



Picture D.1.A

In order to use the scanner, operate as follows:

- select with the scanner the code which corresponds to the frame to be joined
- the machine positions itself on the selected program
- press "EXE" to execute the working cycle



If the selected code does not correspond to an existing program , you will see the following message on the display "B" (see picture D.1.A) "THE PROGRAM DOES NOT EXIST"; in this case operate as indicated at chapter D.2

D. 2 LEARNING A NEW CODE

In order to introduce a new code operate as follows:
from the Main Menù (see dwg D.2) press F2

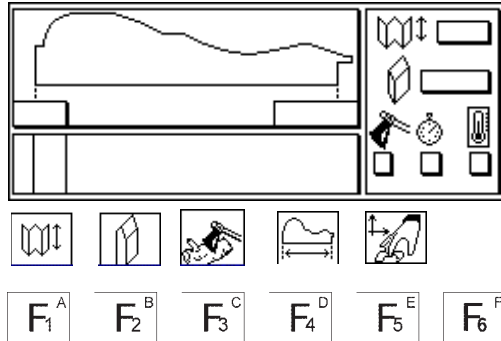

Picture D2

Position the yellow arrows on a new empty line

push "ENTER"

read the bar code which corresponds to the frame which must be joined

execute the programming as indicated at chapter 5.4.11



In order to modify the name of a program which has been already installed, operate as follows:

- from the Main Menù (see dwg D.2) press F2
- select the program to be renamed using the yellow arrows on the keypad
- press F1
- read the new bar code using the scanner

Upgrade version 5.5.0 (February 1999)

A1. File transfer from A Machine to another one

Proceed as follows to transfer programs from the Master machine to the Slave machine:

1. Connect the serial cable to the connectors (Item A of figure 1) on both machines. The connectors are located on the back side of the keypads.



2. Turn on both machines
3. Put the Slave machine (into which you will the copy programs to) on the main menu.

You can transfer :

- a) A single program. (F1)
- b) A block of programs (F2)
- c) All of the programs filed in the memory (F3)



Before transferring any programs, the programs stored in the slave machine must be deleted

A.1.1 Transfer of a single program

To transfer a single program from the Master machine to the Slave Machine proceed as follows on the MASTER machine:

- Press F4 in the main menu to display the programs filed in the machine
- By using the yellow arrows (or by pressing f4) position the cursor on the program to be transferred.
- Press F1 to transfer the program



The program that you just transfered to the Slave machine will occupy the same position/line/code number as it occupied in the Master machine.

A.1.2 Transfer of a bulk of programs

To transfer a bulk of programs from the Master machine to the Slave machine, proceed as follows on the MASTER machine:

- Press F4
- Use the yellow arrow keys to position the cursor on the 1st program to be transferred.
- Press F2
- Type in the last code number of the programs to be transferred, then press enter
- Type in the 1st code/line number on the Slave machine where you want to place the selected programs
- Press Enter to confirm the transmission

A.1.3 Transferring all the programs stored in the Master machine

To transfer all of the programs from the Master machine to the Slave machine, proceed as follows:

- Press the F4 key
- Press the F3 key



The programs will be input into the Slave machine in the same position they had in the master machine. They will replace any programs present in the Slave machine before the transfer.